

LABO ★ K EFFECTS

CONNECTION KIT FOR NEVE V SERIES PREAMP+EQUALIZER

ISS 3.2

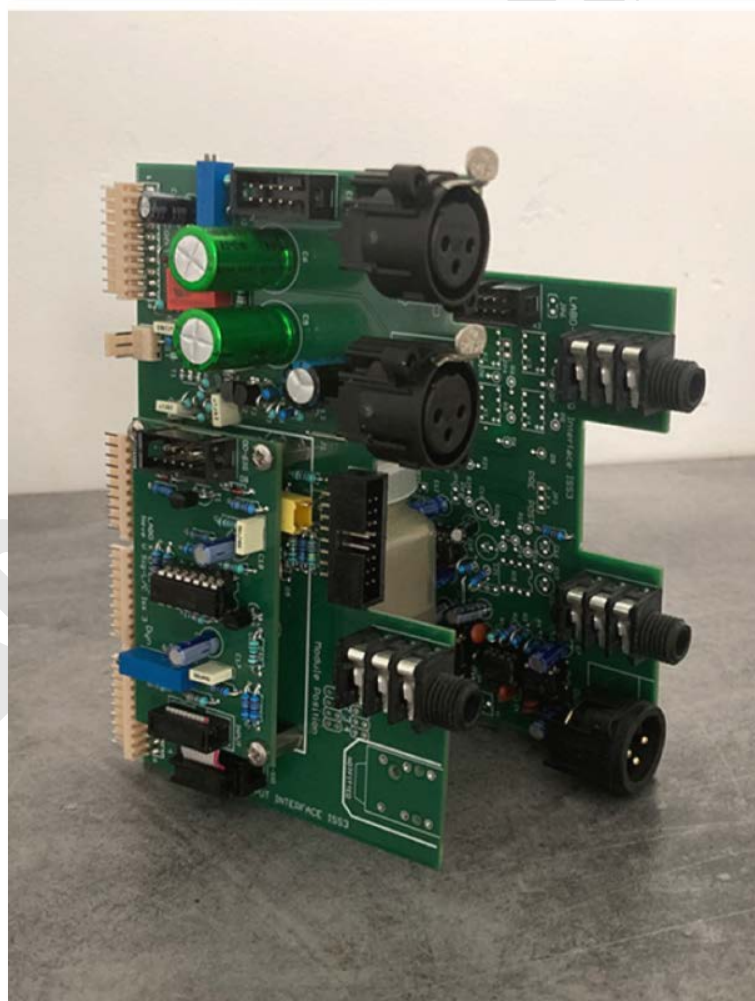

CONTENTS

<i>Introduction.....</i>	<i>4</i>
<i>Positioning dynamics, Equalizer and insert.....</i>	<i>5</i>
<i>Display options.....</i>	<i>6</i>
<i>Kit overview.....</i>	<i>7</i>
<i>agreements.....</i>	<i>8</i>
<i>Options guide.....</i>	<i>9</i>
<i>Input interface card assembly instructions part 1.....</i>	<i>10</i>
<i>Input interface card assembly instructions part 2.....</i>	<i>11</i>
<i>Installation instructions instrument input option part 1.....</i>	<i>12</i>
<i>Installation instructions instrument input option part 2.....</i>	<i>13</i>
<i>Installation instructions instrument input option part 3.....</i>	<i>14</i>
<i>Installation instructions signal overload option part 1.....</i>	<i>15</i>
<i>Installation instructions signal overload option part 2.....</i>	<i>16</i>
<i>Installation instructions signal overload option part 3.....</i>	<i>17</i>
<i>Assembly instructions sig/lc plug-in card part 1.....</i>	<i>18</i>
<i>Assembly instructions sig/lc plug-in card part 2.....</i>	<i>19</i>
<i>Assembly instructions sig/lc plug-in card part 3.....</i>	<i>20</i>
<i>Assembly instructions sig/lc plug-in card part 4.....</i>	<i>21</i>
<i>DLX plugin board assembly instructions part 1.....</i>	<i>22</i>
<i>DLX plugin board assembly instructions part 2.....</i>	<i>23</i>
<i>DLX plugin board assembly instructions part 3.....</i>	<i>24</i>
<i>DLX plugin board assembly instructions part 4.....</i>	<i>25</i>
<i>DLX plugin board assembly instructions part 5.....</i>	<i>26</i>
<i>EQ interface board assembly instructions part 1.....</i>	<i>27</i>
<i>EQ interface board assembly instructions part 2.....</i>	<i>28</i>
<i>EQ interface board assembly instructions part 3.....</i>	<i>29</i>
<i>EQ interface board assembly instructions part 4.....</i>	<i>30</i>
<i>Assembly instructions matrix insertion option.....</i>	<i>31</i>
<i>Installation instructions LED meter part 1.....</i>	<i>32</i>
<i>Installation instructions LED meter part 2.....</i>	<i>33</i>
<i>Installation instructions LED meter part 3.....</i>	<i>34</i>
<i>Installation instructions LED meter part 4 dlx.....</i>	<i>35</i>
<i>Analog vumetre assembly instructions part 1.....</i>	<i>36</i>
<i>Analog vumetre assembly instructions part 2.....</i>	<i>37</i>
<i>Analog vumetre assembly instructions part 3.....</i>	<i>38</i>
<i>Assembly instructions signalling options.....</i>	<i>39</i>
<i>Making the connection cables.....</i>	<i>40</i>

Chain of dynamics	41
wiring the elements part 1	42
wiring the elements part 2	43
Checks	44
Settings and adjustments.....	45
Input interface board components list part 1	46
Input interface board components list part 2	47
List of sig/lc plugin board components	48
List of DLX plugin board components	49
List of sig/lc led board components	50
List of DLX led board components	51
EQ interface board components.....	52
Insert matrix components.....	53
LED vumetre driver components	54
Analog vumetre driver components.....	55
Pinouts.....	56
Drilling template	57



INTRODUCTION

This kit allows to interconnect one NEVE V series preamp module and one equalizer module to put them into a Rack.

The kit also allows to connect inputs, outputs and power supply necessary for the use of the set.

The PSU bus system allows to connect up to 8 modules (4 preamp and EQ pairs) rather arranged vertically.

This bus also allows to wire the side chain function of the compressors / gates.

It connects the inputs, outputs and power supply needed to use the unit by minimizing the wiring perform.



Adding an optional High impedance Instrument input is provided to the kit.

The "plug and play" design of this kit is usefull to verify the proper operation of modules before moving on to the racking.

Possibilities provided by this kit.

- Configurable position of dynamics, equaliser and insertion.
- Provision for 2 LED and analogue VU meter drivers.
- Planned installation of a high-impedance instrument input following the path of the microphone preamp via its input transformer.
- Addition of a rotary fader

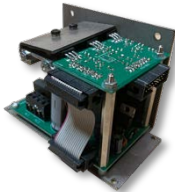
Optional accessories

<p>Labo★K Effects Neve V PSU Kit</p> <p>Regulated PSU +48V, +/-16V,-15VLogic (Kit or Built and tested)</p> <p><i>Transformer not supplied</i></p>	
<p>Labo★K Effects Mounting clip</p> <p>Matching NEVE 51 and V series Allow to fix module on front plate. Matching with Input & Equalizer.</p>	



For proper operation of the unit, it is advisable to use modules in good conditions and with coupling capacitors that will have been replaced if necessary.

The poor condition of the capacitors can greatly affect the sound quality or even cut the signal. Similary, one will ensure that the various switches have been cleaned using a contact cleaner spray.

POSITIONING DYNAMICS, EQUALIZER AND INSERT

4 modes for matrixing dynamics, Equalizer and Insertion:

▪ Standard

The audio path passes through the dynamics, the equaliser and the insert. The **PREQ** button on the equaliser module places the insert at the beginning of the chain.

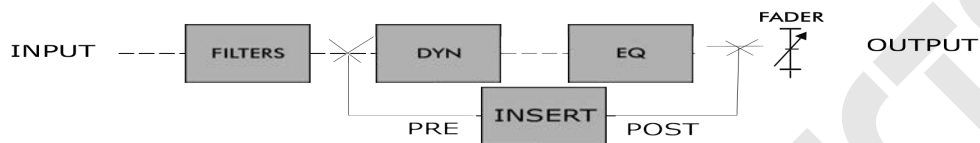

▪ Swap

This mode swaps the position of the dynamics and the equaliser. The **PREQ** button on the equalizer module places the Insert at the start of the chain.

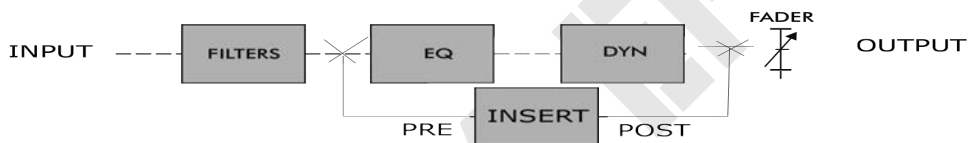

▪ Mid

This mode places the insert between the dynamics and the equaliser. The **PREQ** button on the equaliser module is not used.

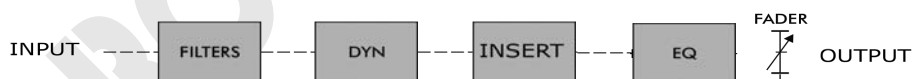

▪ Mid and Swap together

This mode places the insert between the equaliser and the dynamics. The **PREQ** button on the equalizer module is not used.

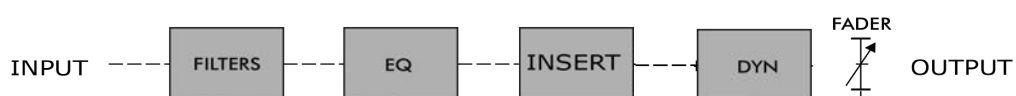

DISPLAY OPTIONS

Various signal display options are available:

- Display of input/output signal via LED meter.
- LED display to indicate presence of signal or overload.
- Display of input or output signal via analogue meter.
- Display of gain reduction via two-colour LED (Type V3 Sig/LC LED).
- 8 LED gain reduction display (VR DLX LED type)



Standard LED



DLX LED

Optional features

- An adjustable threshold signal and overload detector on the Input card.
- An LED vumeter driver on the EQ board.
- An analogue vumeter driver on the EQ card.
- A gain reduction led bi-colour V3 measurement system (Sig/LC plug-in card).

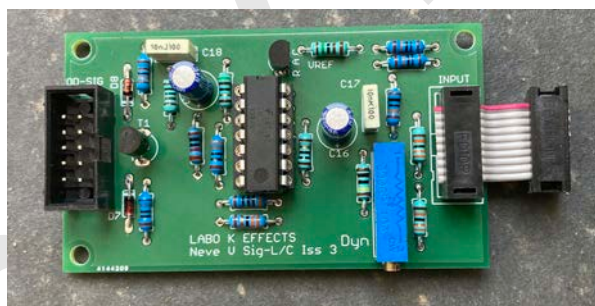

- An 8-LED gain reduction measurement system VR type (DLX plug-in card).

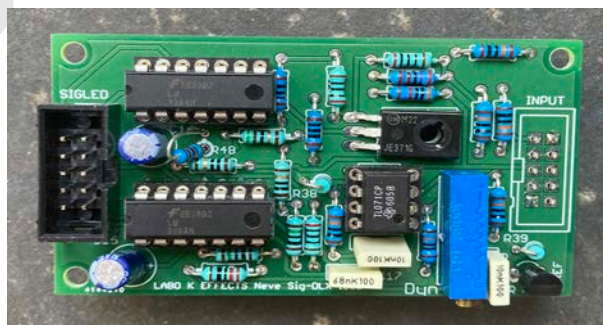

- A high-impedance input with FET transistors on the Input card.
- Possibility of adding an output fader/potentiometer to the EQ card.

KIT OVERVIEW

A card (Input interface) to connect:

- 1 Preamp/Dynamic module
- Micro, Line and Key inputs
- Signal indicators and gain reduction of the compressor. (optional)
- PSU Bus, Dynamic link
- 1 high impedance instrument input (option).

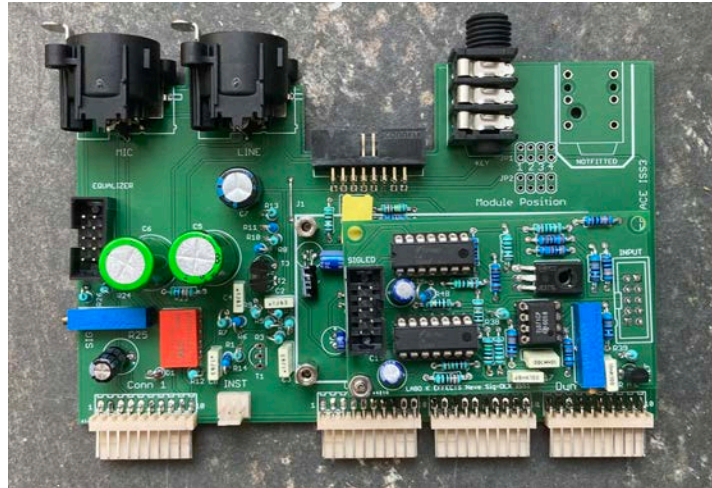

A card (EQ interface) to connect:

- 1 Equalizer Module
- PSU bus.
- Un vumètre à LED et/ou analogique (option)
- 1 +4db balanced output (stage fitted on the PCB)
- Insertion send balanced.
- Insertion return balanced.
- 1 volume fader (option)

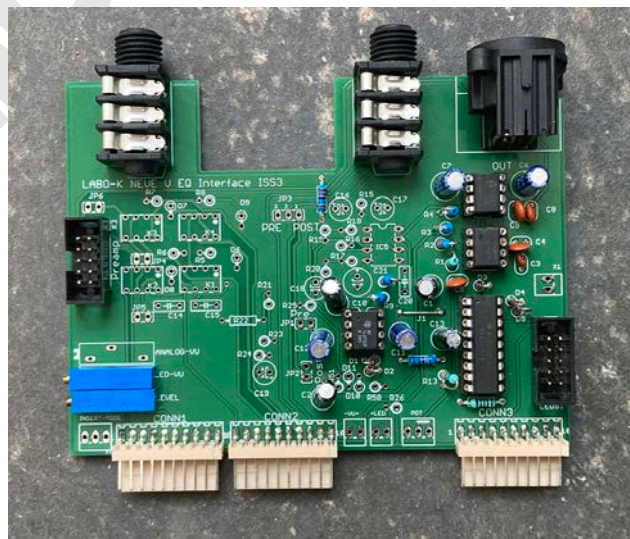

AGREEMENTS

Component layout

Vertical layout of diodes

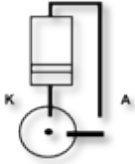

Straps are made using component tails.

The tabs of the Molex KK connectors is located on the edge of the board.

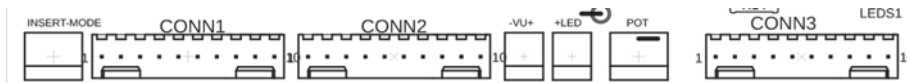

Locating

Pin 1 of the Molex KK connectors is on the left.

Pin 1 of the IDC connectors is marked with a triangle.

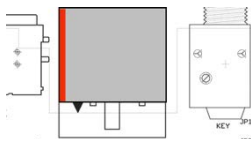

Wiring

Molex connectors

The various connections via male Molex KK connectors are made using soldered wires sleeved onto the pins.

It is of course possible to crimp the cables into female Molex KK connectors (not supplied) to make these connections.

KK female connectors to be used

Molex **KK254**

Crimps **08-50-0032**

IDC connectors

Only IDC connectors are supplied with the kit.

The ribbon cable to be used is 28 AWG pitch 1.27 with 16 strands.

For IDC 10 connectors, 6 strands must be removed from cable 16, keeping the red strand. The ribbons in the VU/Gain reduction section have 20 strands to be separated into 2 x 10 once the 20-pin connector has been crimped. This will form a Y with 2 10-pin connectors at the end of the 2 legs.

Shielded cables

The instrument input and potentiometer are wired using shielded pairs such as Mogami 3931-2 pairs, for example. 1 meter will be sufficient for 2 channels.

OPTIONS GUIDE

building the Input interface card

Basic version	
Pages Assembly instructions	Pages Components list
10-11	46
Instrument input	
12-13-14	46
V3 type LED meter display with gain reduction (Sig L/C)	
15-16-17-18-19-20-21	47-48-50
VR type LED meter with gain reduction (DLX)	
15-16-17-22-23-24-25-26	47-49-51

Réalisation de la carte EQ interface

Basic version	
Pages Assembly instructions	Pages Components list
27-28-29-30	52
Insertion matrix	
31	53
V3 type LED meter display with gain reduction (Sig L/C)	
32-33-34-39	54
VR type LED meter with gain reduction (DLX)	
32-33-34-35-39	54
Analog Vumeter	
36-37-38 39	55

INPUT INTERFACE CARD ASSEMBLY INSTRUCTIONS PART 1

	100R	R1	1
	47u63V	C1	1
	J1	Strap (component tail)	1
	IDC 16	PSU BUS	1
	IDC 10	Equalizer	1

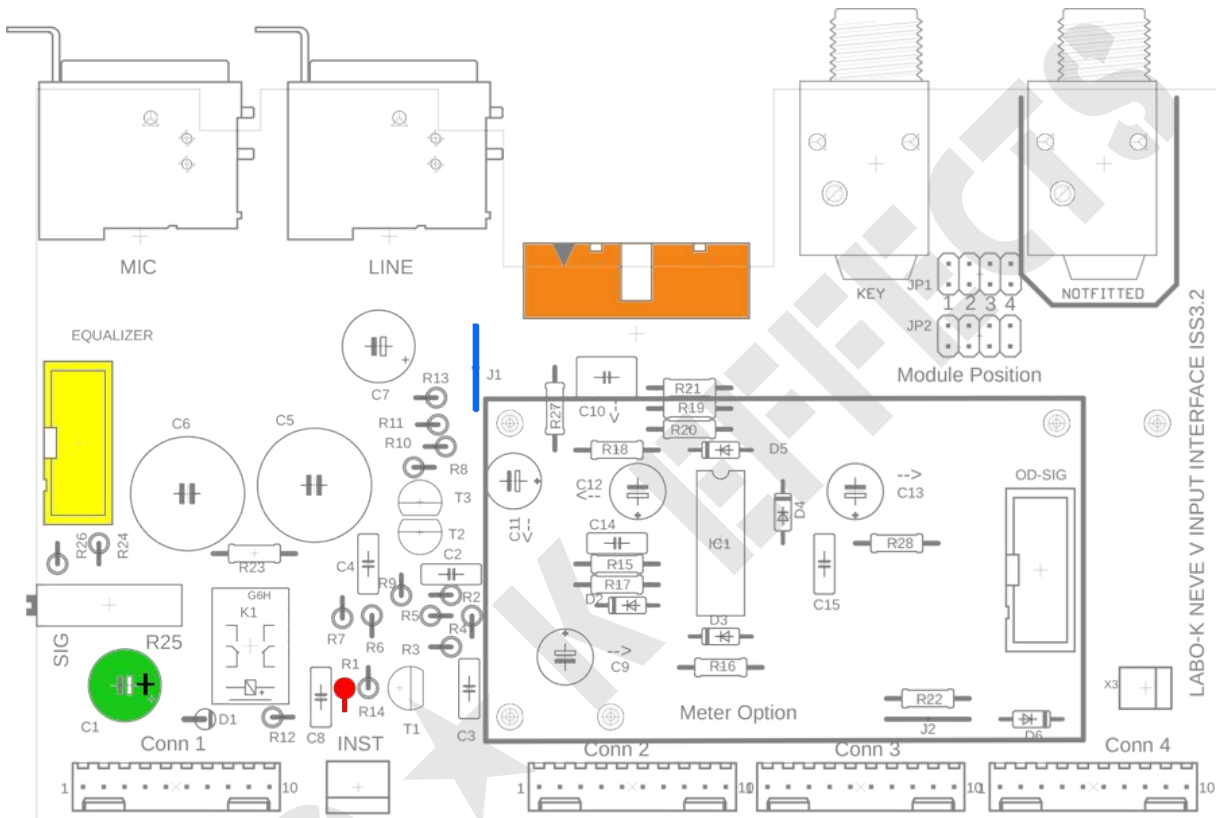

Pay attention to :

The + side of the polarised capacitor (generally the longer leg)

IDC 10 connector notch

INPUT INTERFACE CARD ASSEMBLY INSTRUCTIONS PART 2

	KK 10 connector	Conn1 - Conn4	4
	XLR F	MIC, LINE	2
	TRS Jack	KEY	1
	Strap	Only if Di input is not used	2

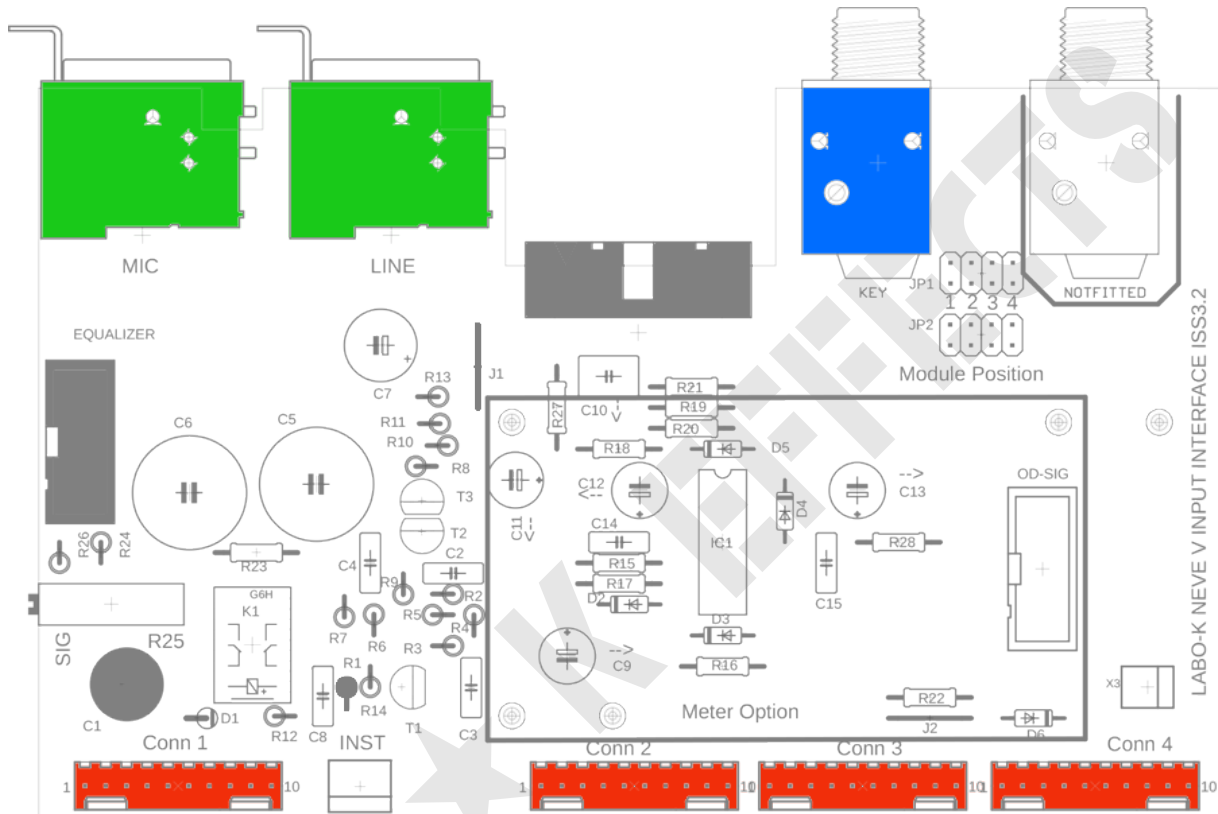

Pay attention to :

KK10 connector orientation

INSTALLATION INSTRUCTIONS INSTRUMENT INPUT OPTION PART 1

	22R	R9	1
	100R	R8, R11	2
	470R	R6	1
	2M2	R2, R3, R4, R5, R7, R10, R13	7
	3K3	R12	1

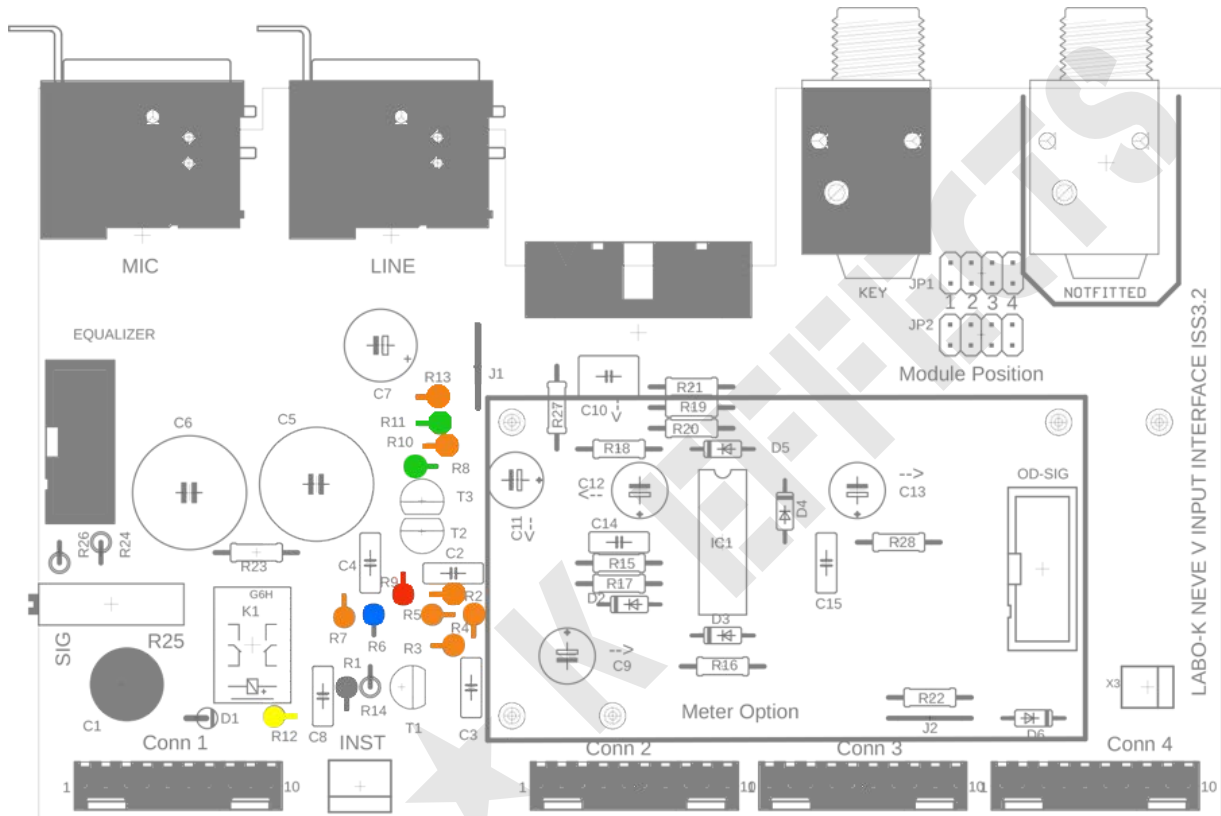

INSTALLATION INSTRUCTIONS INSTRUMENT INPUT OPTION PART 2

	10K	R14	1
	100n Film	C2, C3, C4, C8	4
	100u63V BP	C5, C6	2
	100u63V	C7	1
	Relay	K1	1

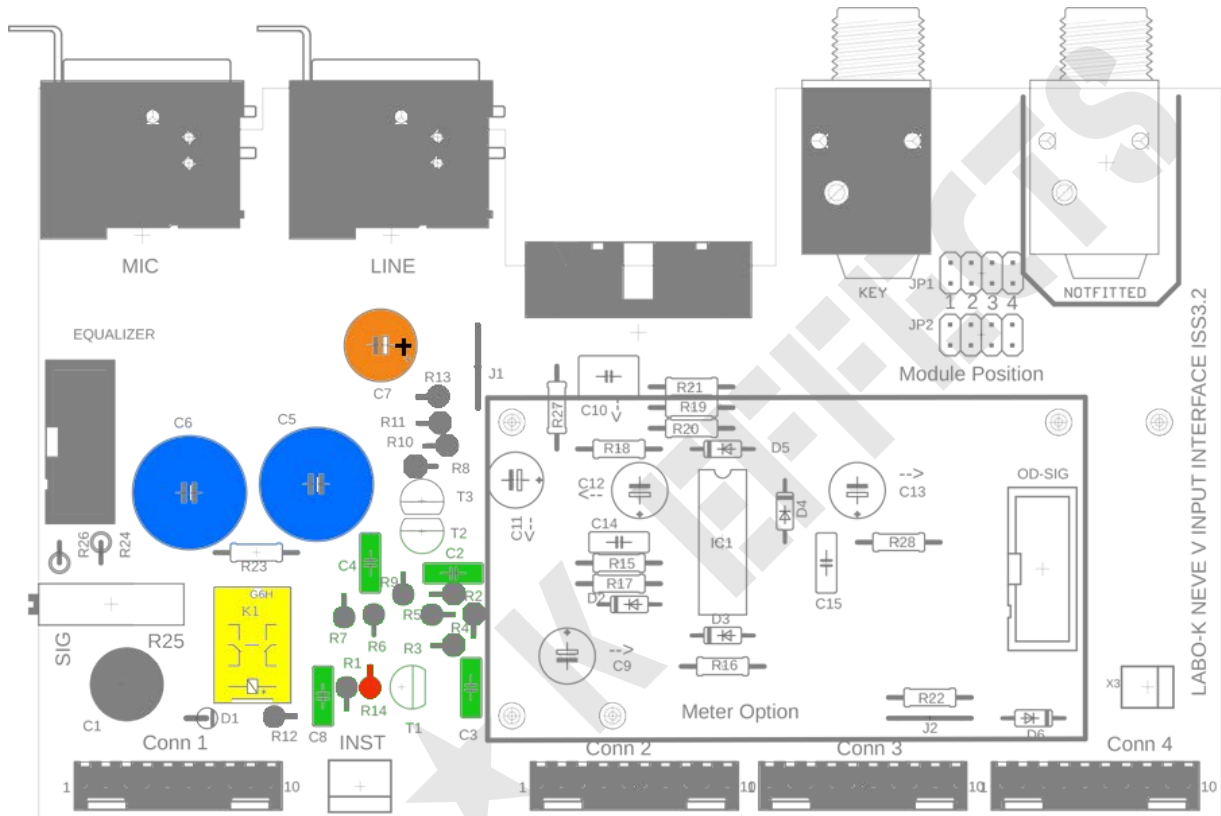

Pay attention to :
Relay positioning

INSTALLATION INSTRUCTIONS INSTRUMENT INPUT OPTION PART 3

	1N4148	D1
	2N3004	T1
	K170 BL	T2, T3
	KK 3	INST

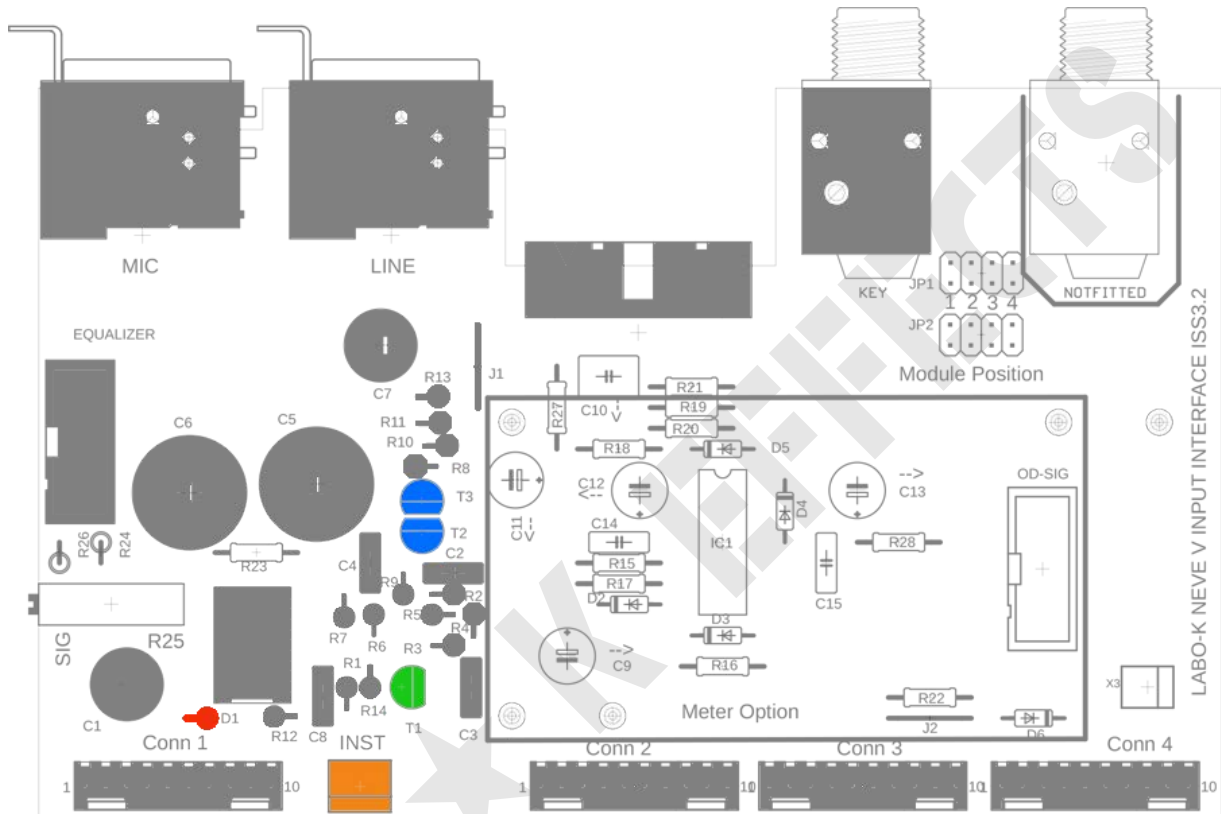

Pay attention to :

- Diode polarity
- Transistor orientation
- KK3 connector orientation

INSTALLATION INSTRUCTIONS SIGNAL OVERLOAD OPTION PART 1

	51R	R27, R28	2
	1K3	R22	1
	3K3	R20	1
	10K	R15, R16, R17, R18, R19	5
	68K	R24, R26	2

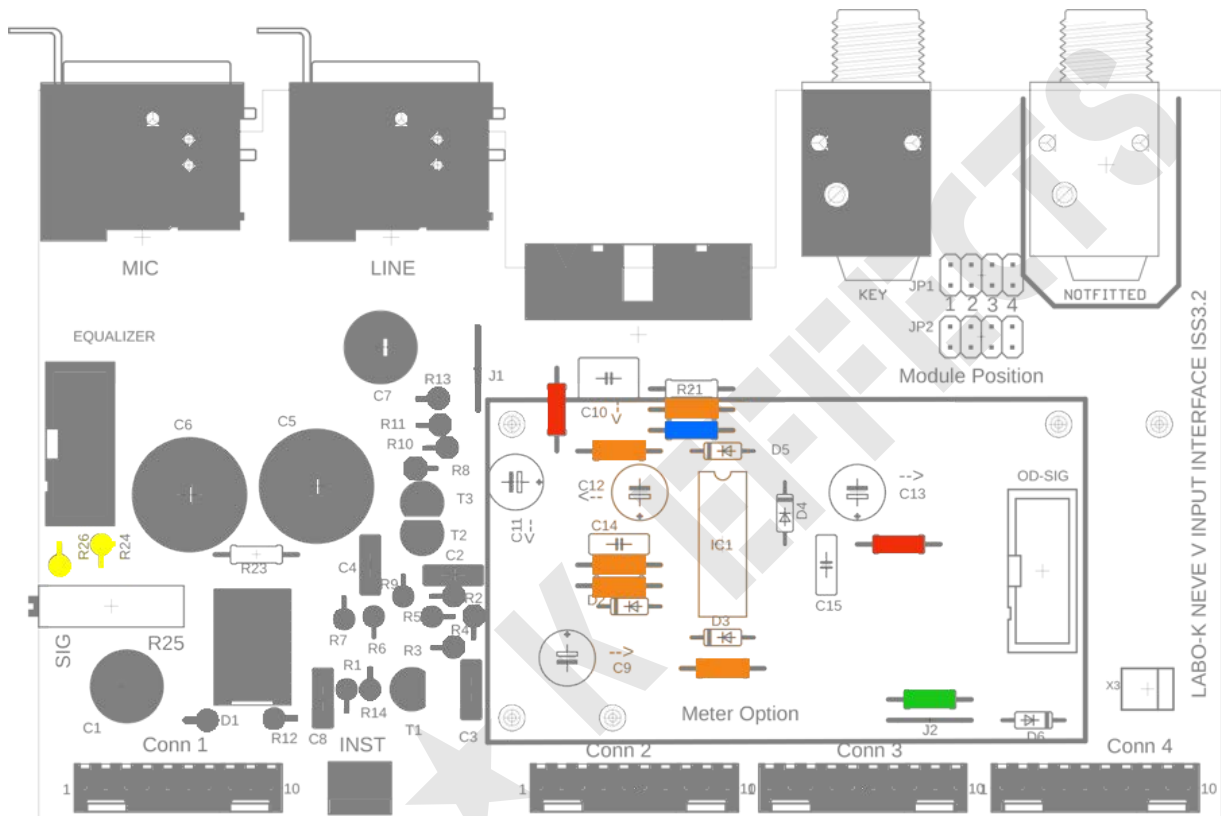

Pay attention to :

KK10 connector orientation

Note: J2 jumper not fitted

INSTALLATION INSTRUCTIONS SIGNAL OVERLOAD OPTION PART 2

	2M2	R21	1
	560K	R23	1
	Trimmer 10K	R25 SIG	1
	22n Film	C14, C15	2
	680n Film	C10	1

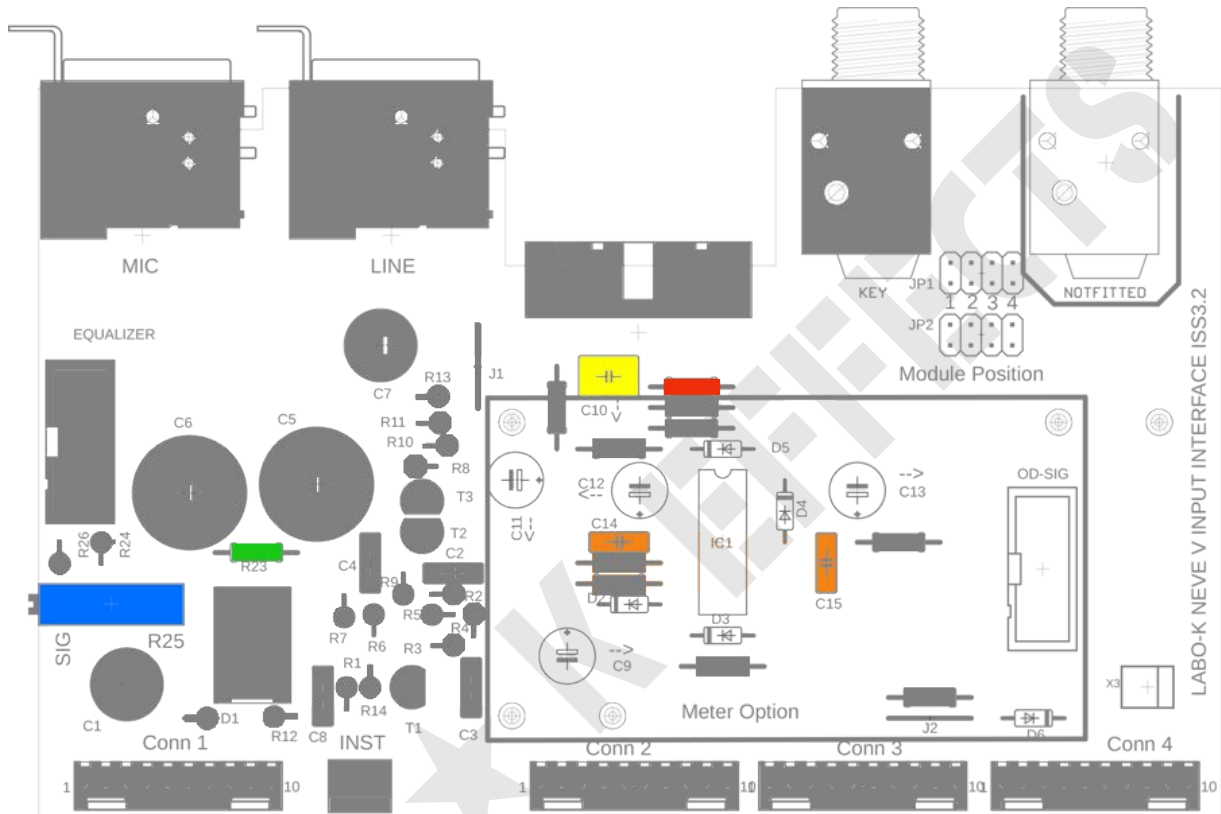

INSTALLATION INSTRUCTIONS SIGNAL OVERLOAD OPTION PART 3

	2u2/63V	C11	1
	22u25V	C9, C12, C13	3
	1N4148	D2, D3, D4, D5, D6	5
	TL064	IC1+DIL14 socket	1
	IDC 10	OD-SIG	1

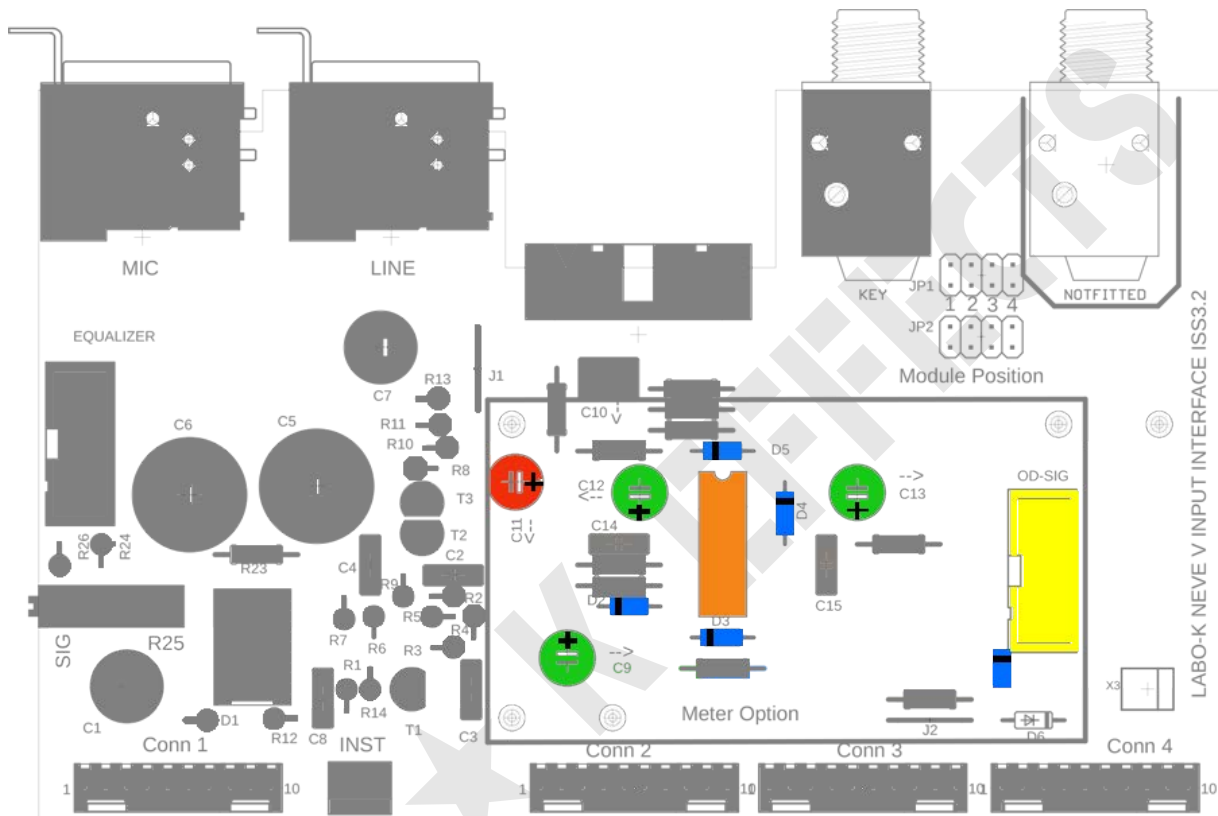

Pay attention to :

- Diode orientation
- Orientation of polarised capacitors
- Orientation of the OD-SIG IDC connector

Capacitors with an arrow next to their name should be placed in the direction of the arrow. This will make it easier to install the optional plug-in.

ASSEMBLY INSTRUCTIONS SIG/LC PLUG-IN CARD PART 1

	33R	R36	1
	51R	R44, R45	2
	300R	R37	1
	330R	R38	1
	680R	R43	1

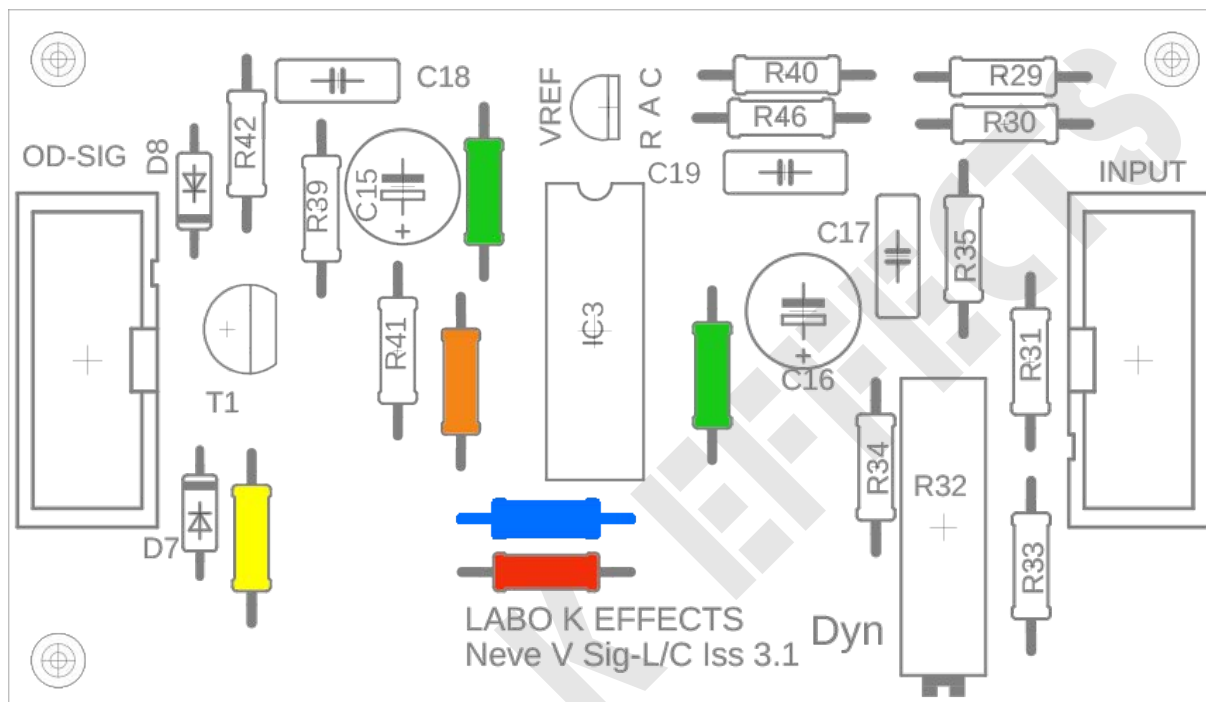

ASSEMBLY INSTRUCTIONS SIG/LC PLUG-IN CARD PART 2

	1K	R39	1
	1K3	R42	1
	1K5	R40	1
	10K	R41	1
	100K	R29, R30, R35	3

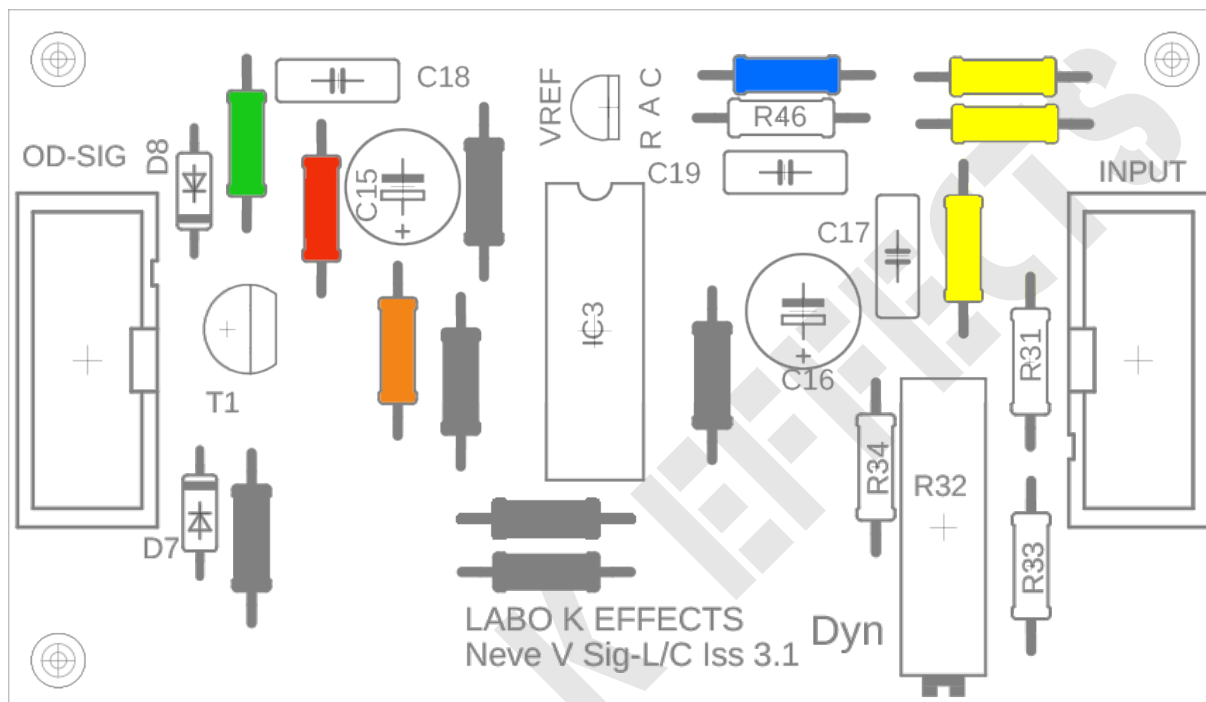

ASSEMBLY INSTRUCTIONS SIG/LC PLUG-IN CARD PART 3

	330K	R31, R33	2
	1M	R34	1
	Trimmer 10K	R32 DYN	1
	10n Film	C 17, C18	2
	22u25V	C15, C16	2

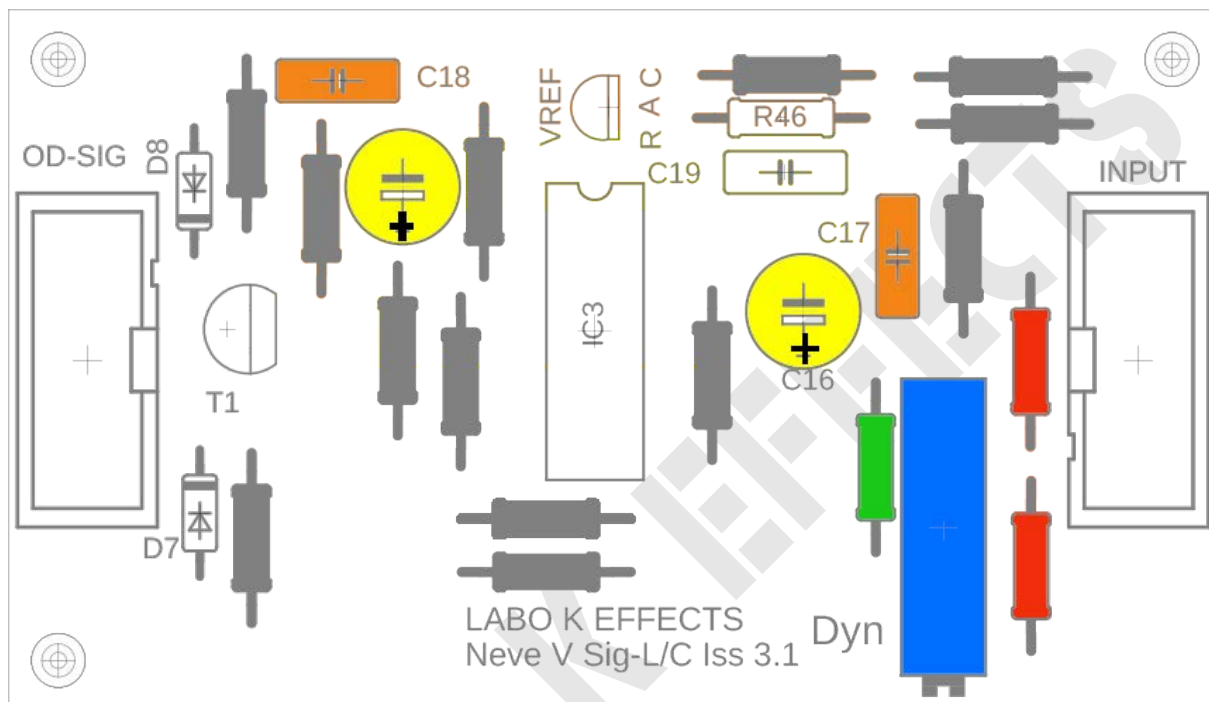

Pay attention to :

Orientation of polarised capacitors

ASSEMBLY INSTRUCTIONS SIG/LC PLUG-IN CARD PART 4

	1N4148	D7, D8	2
	TL431	VREF	1
	LM339	IC3 +DIL14 Socket	1
	2N2222	T1	1
	IDC 10 Male	OD-SIG (See note for INPUT)	2

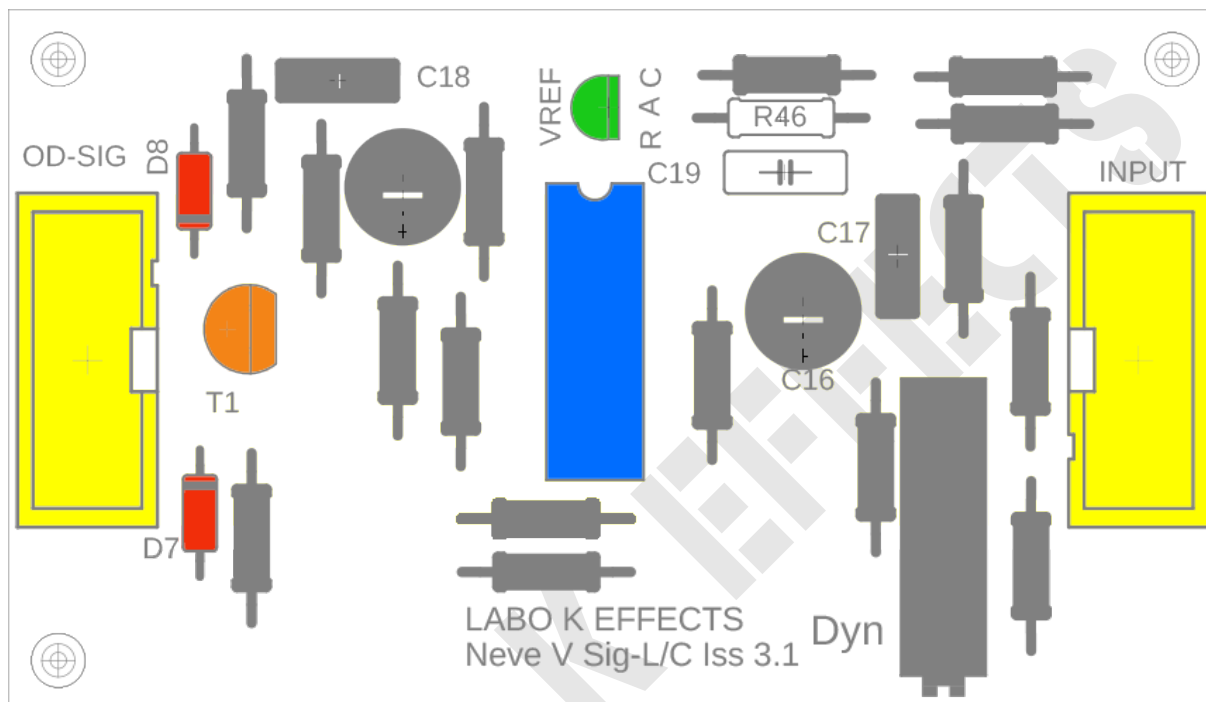

Pay attention to :

- | |
|----------------------------------|
| Diode orientation |
| Orientation of IDC 10 connectors |
| |
| |

DLX PLUGIN BOARD ASSEMBLY INSTRUCTIONS PART 1

	10R	R36, R37	2
	51R	R47, R48	2
	100R	R44, R46	2
	150R	R42, R43	2
	200R	R41, R45, R49	3

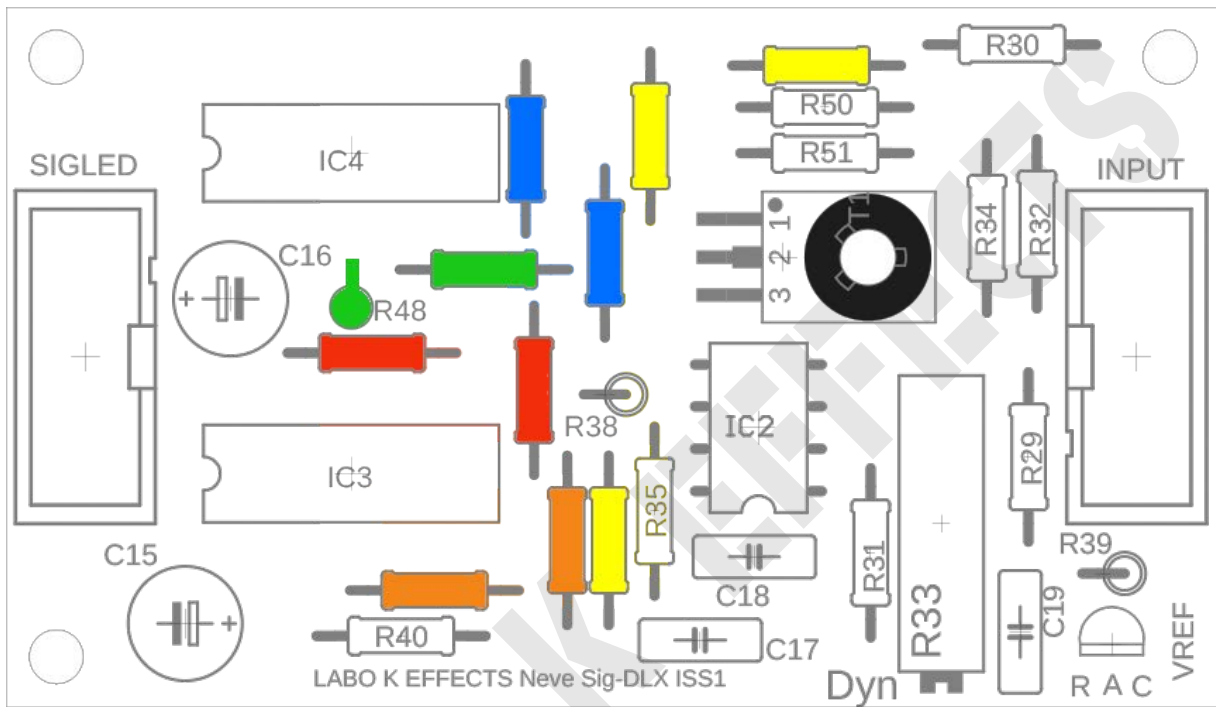

DLX PLUGIN BOARD ASSEMBLY INSTRUCTIONS PART 2

	220R	R40	1
	1K5	R39	1
	2K7	R50	1
	15K	R38	1
	30K	R51	1

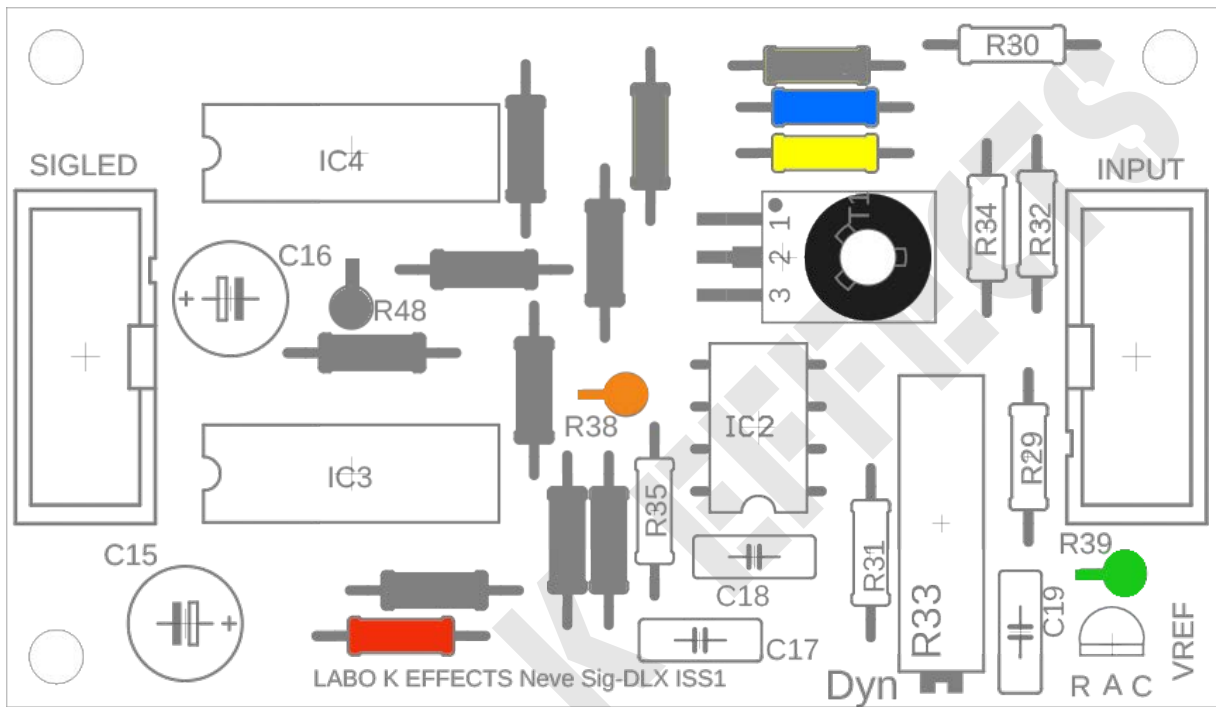

DLX PLUGIN BOARD ASSEMBLY INSTRUCTIONS PART 3

	100K	R29, R30, R31, R32, R34, R35	6
	Trimmer 10K	R33-DYN	1
	10n Film	C17, C19	2
	22n Film	C18	1
	22u25V	C15, C16	2

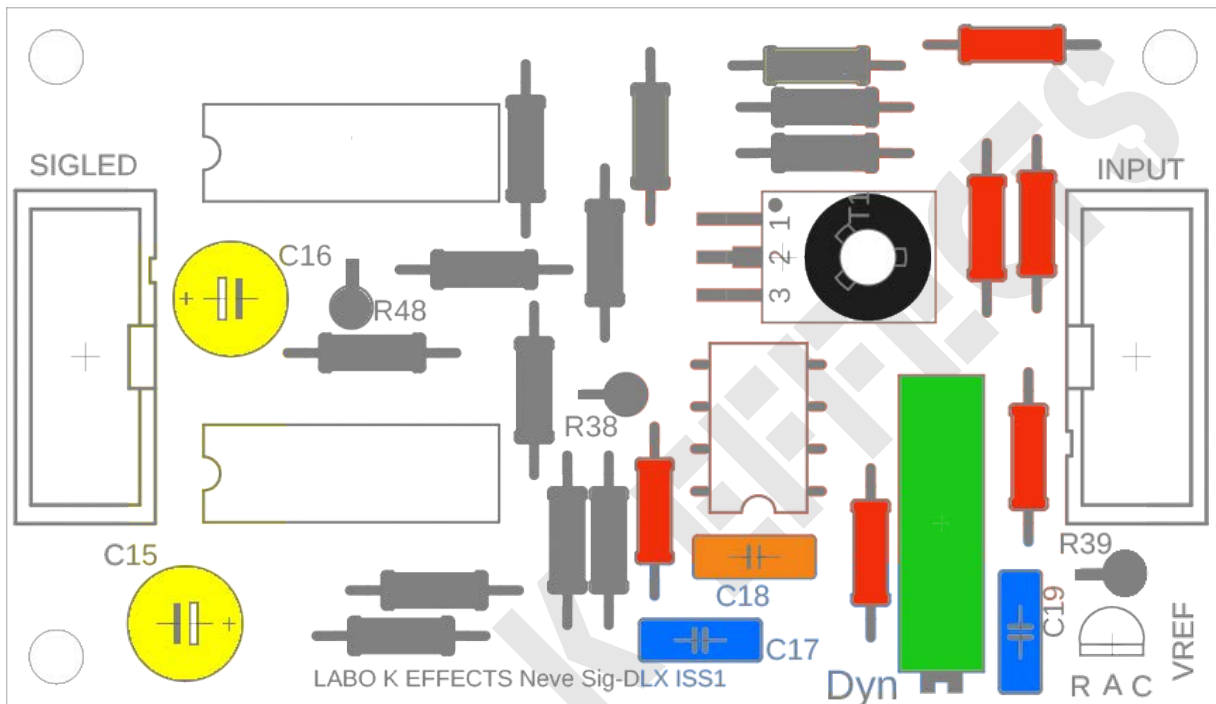

Pay attention to :

Orientation of polarised capacitors

DLX PLUGIN BOARD ASSEMBLY INSTRUCTIONS PART 4

	TL071	IC2+Support	1
	LM339	IC3, IC4+ DIL14 Sockets	2
	TL431	VREF	1
	IDC 10	SIGLED (see note for INPUT)	1
	MJE371	T1	1

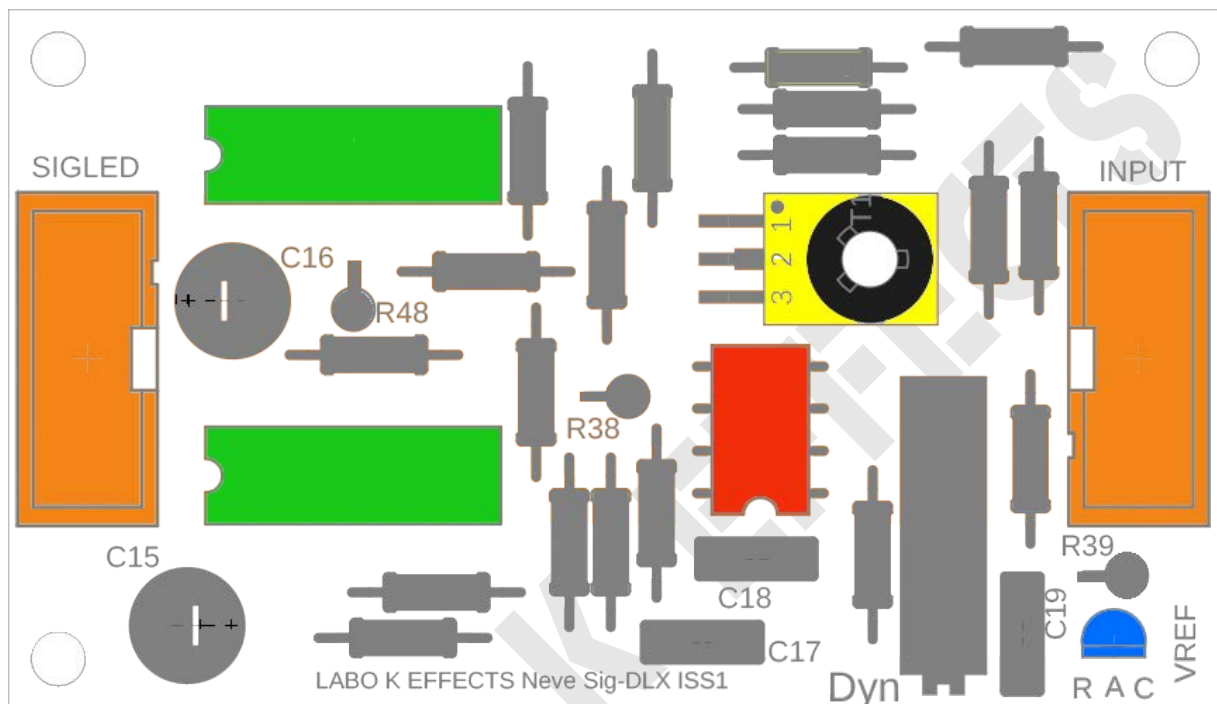

Pay attention to :

- | |
|---|
| Orientation of IDC 10 connector |
| Positioning of transistor T1 (visible mark) |
| |
| |

DLX PLUGIN BOARD ASSEMBLY INSTRUCTIONS PART 5

	KK2	X1	1

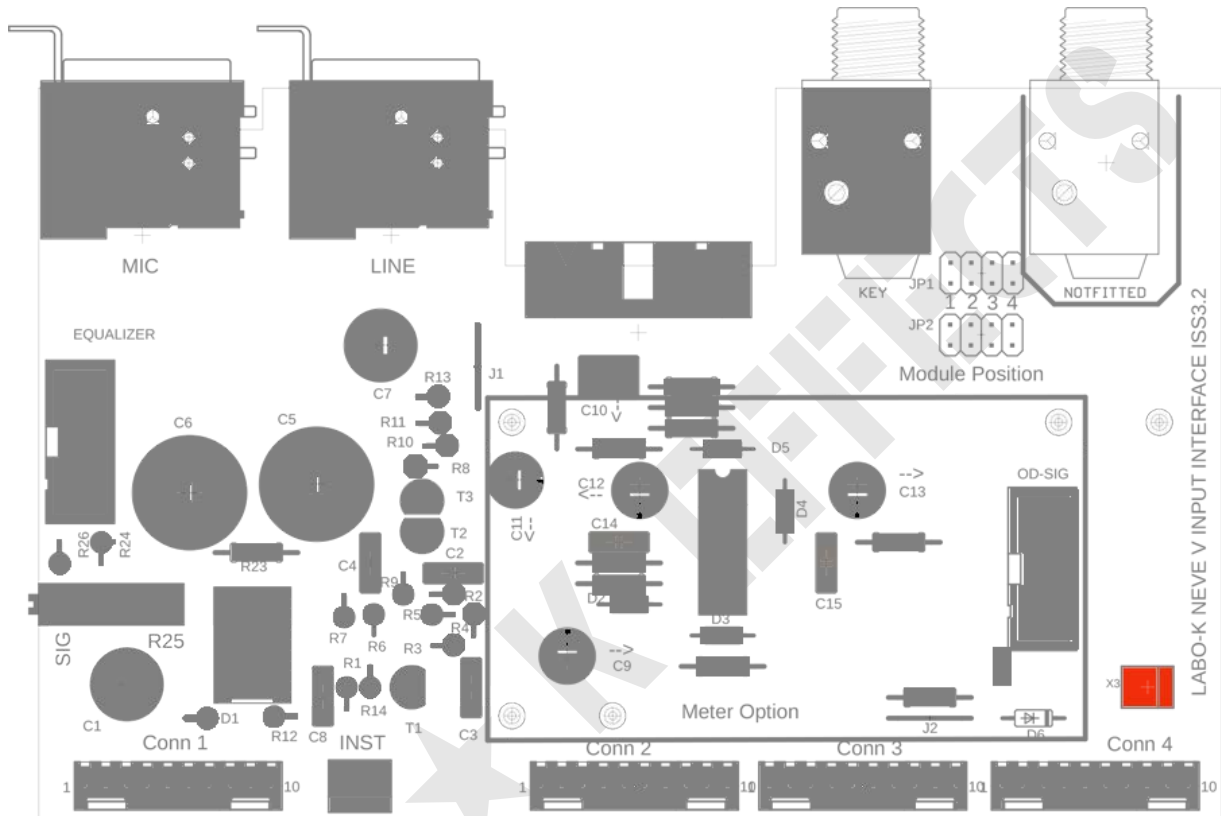

Pay attention to :
KK2 connector orientation

EQ INTERFACE BOARD ASSEMBLY INSTRUCTIONS PART 1

	18K	R1	1
	1K2	R2	1
	3K6	R3	1
	Trimmer 10K	LEVEL	1

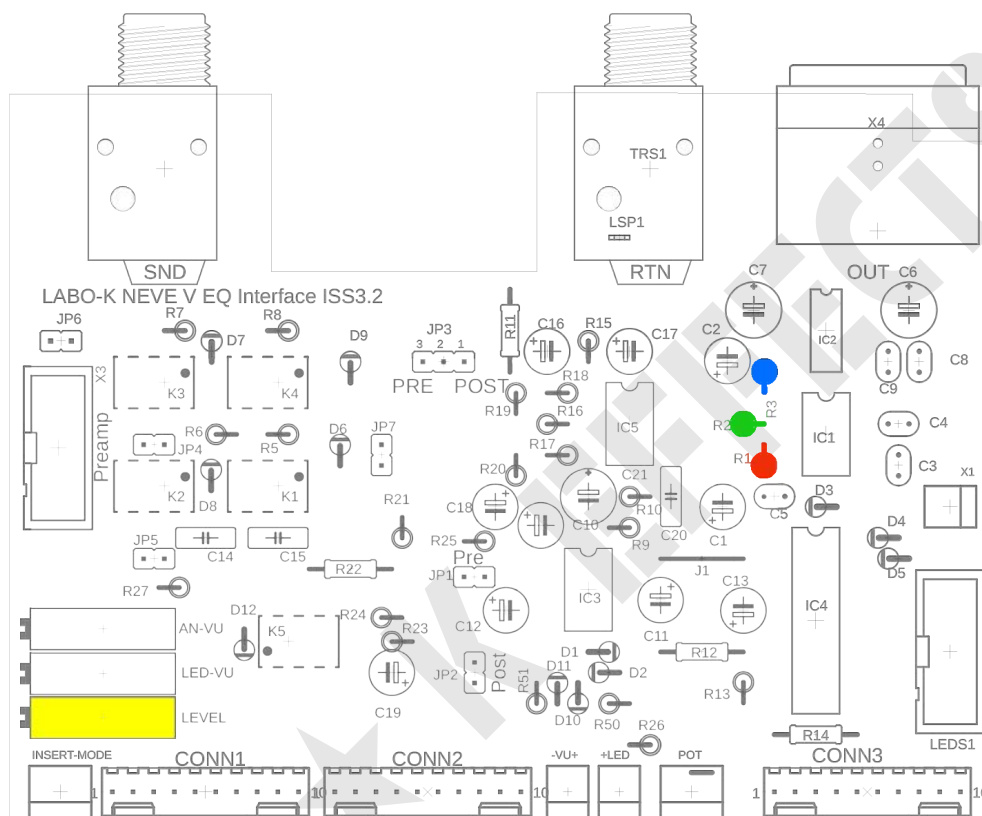

EQ INTERFACE BOARD ASSEMBLY INSTRUCTIONS PART 2

	22p Céramique	C3	1
	100n Céramique	C4, C5, C8, C9	4
	22u25V	C6, C7	2
	100u10V	C1, C2	2
	DIL 8 socket	IC1, IC2	2

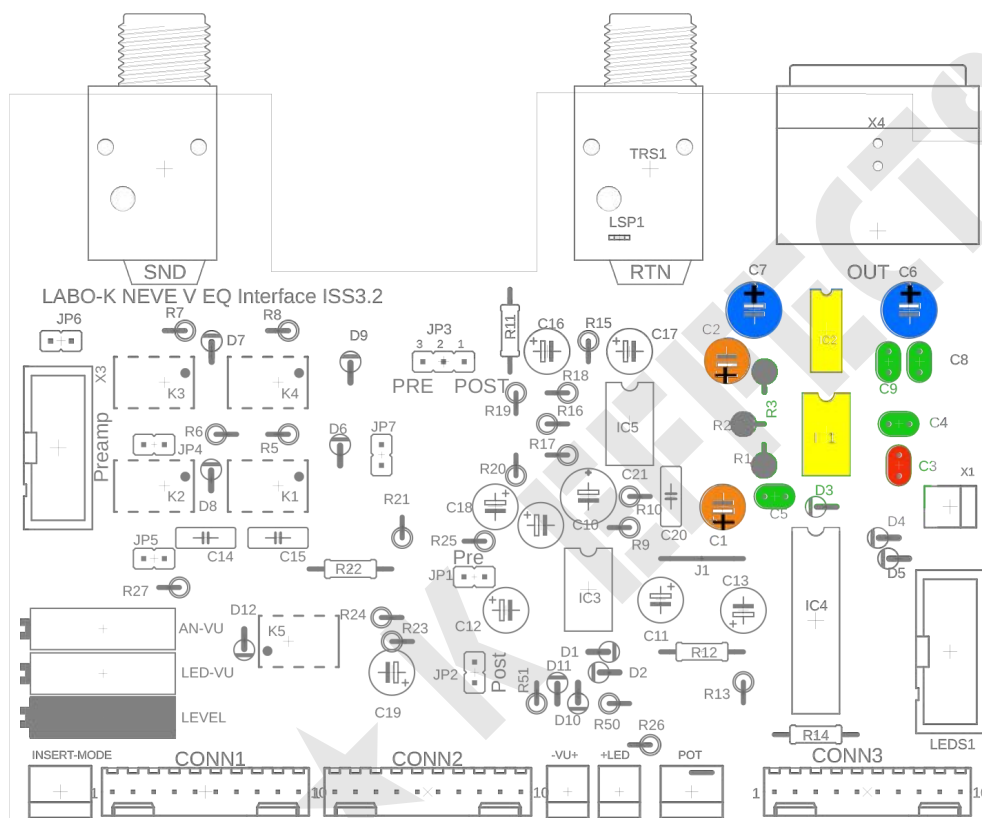

Pay attention to :
Orientation of polarised capacitors

EQ INTERFACE BOARD ASSEMBLY INSTRUCTIONS PART 3

	KK 3 connector	Pot	1
	KK 10 connector	CONN1-CONN 3	3
	IDC 10 male	Preamp	1
	TRS Jack	SND, RTN	2
	XLR 3 Male	OUT	1

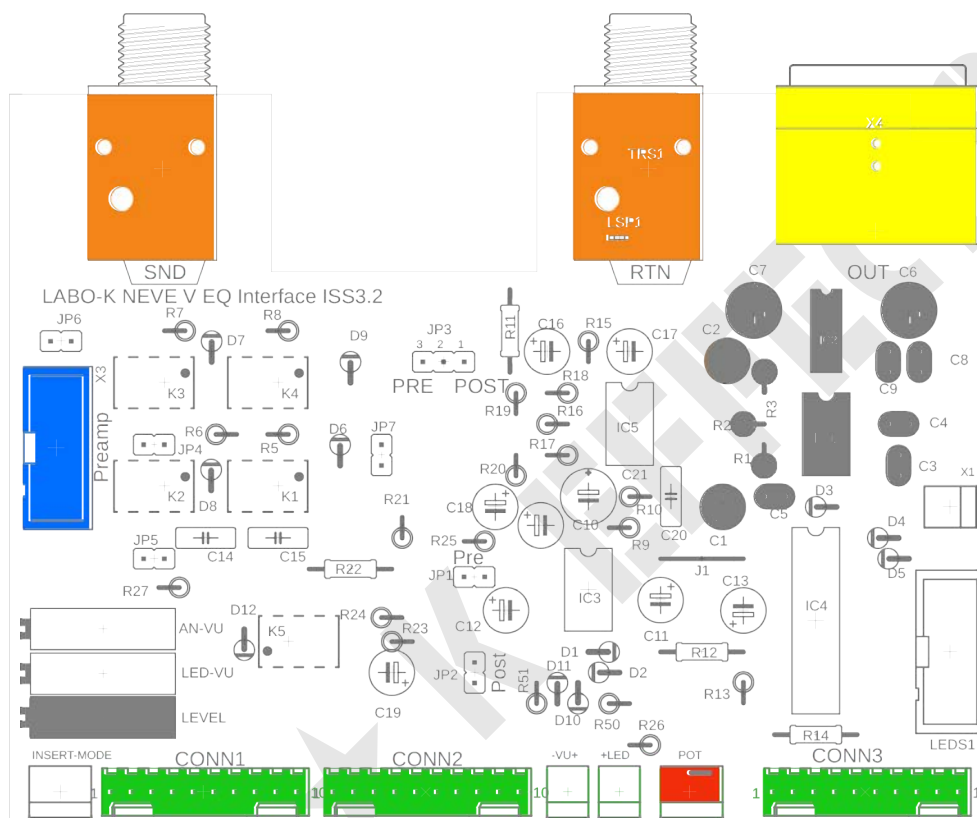

Pay attention to :
Orientation of KK and IDC connectors

EQ INTERFACE BOARD ASSEMBLY INSTRUCTIONS PART 4

	NE5534	IC1	1
	THAT1646	IC2	1
	STRAPS	JP4, 5, 6, 7 (If matrix option not used)	
	Jumper	Pot (do not fit if Fader option)	2
			1

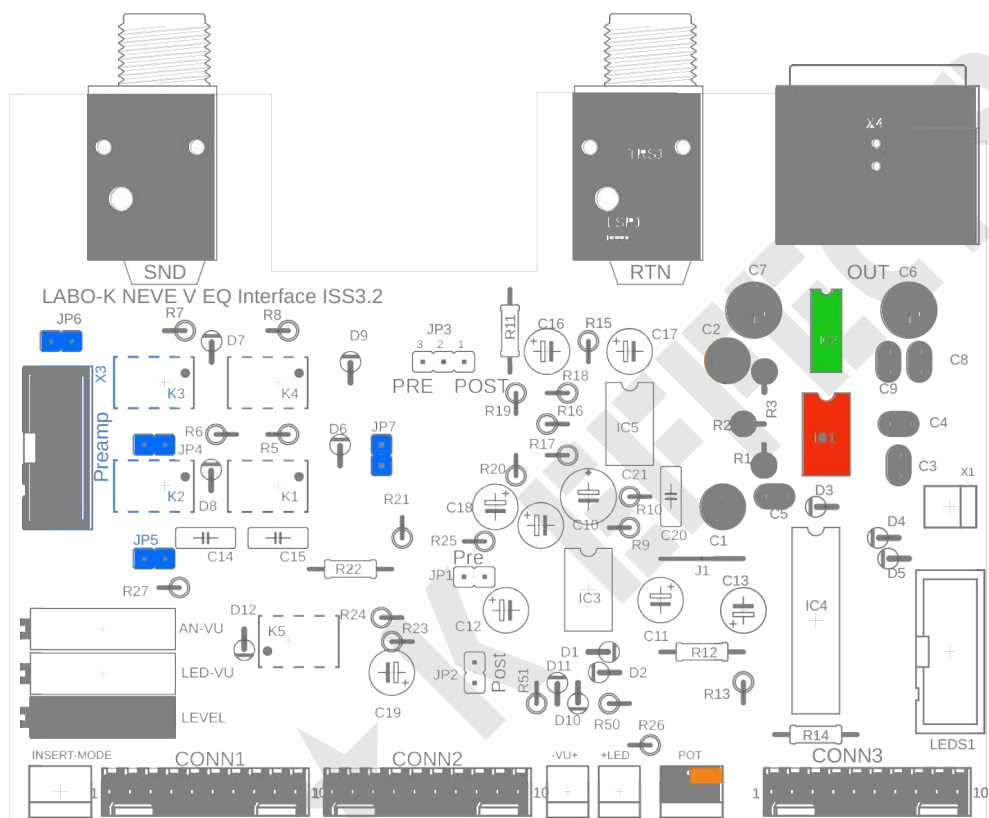

Pay attention to :

Orientation of KK and IDC connectors

If the Matrix option is not used
Place steps in JMP 4 to 7

ASSEMBLY INSTRUCTIONS MATRIX INSERTION OPTION

	3K	R5, R6, R7, R8, R27	5
	1N4148	D6, D7, D8, D9, D12	5
	100n Film	C14, C15	2
	G6K 12	K1, K2, K3, K4, K5 (Relays)	5
	Molex KK3	INSERT MODE	1

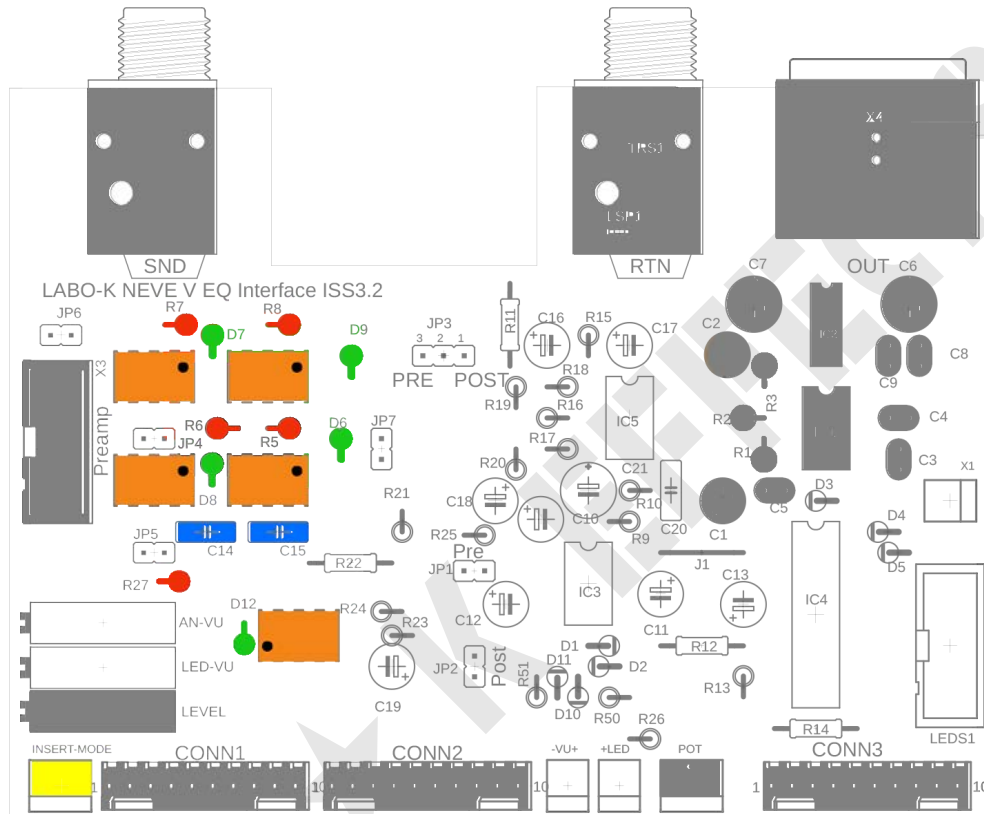

Pay attention to :
Relay orientation
KK3 connector orientation

INSTALLATION INSTRUCTIONS LED METER PART 1

	Jumper	J1	1
	100R	R10, R11	2
	180R	R12	1
	1K	R14	1
	3K3	R13	1

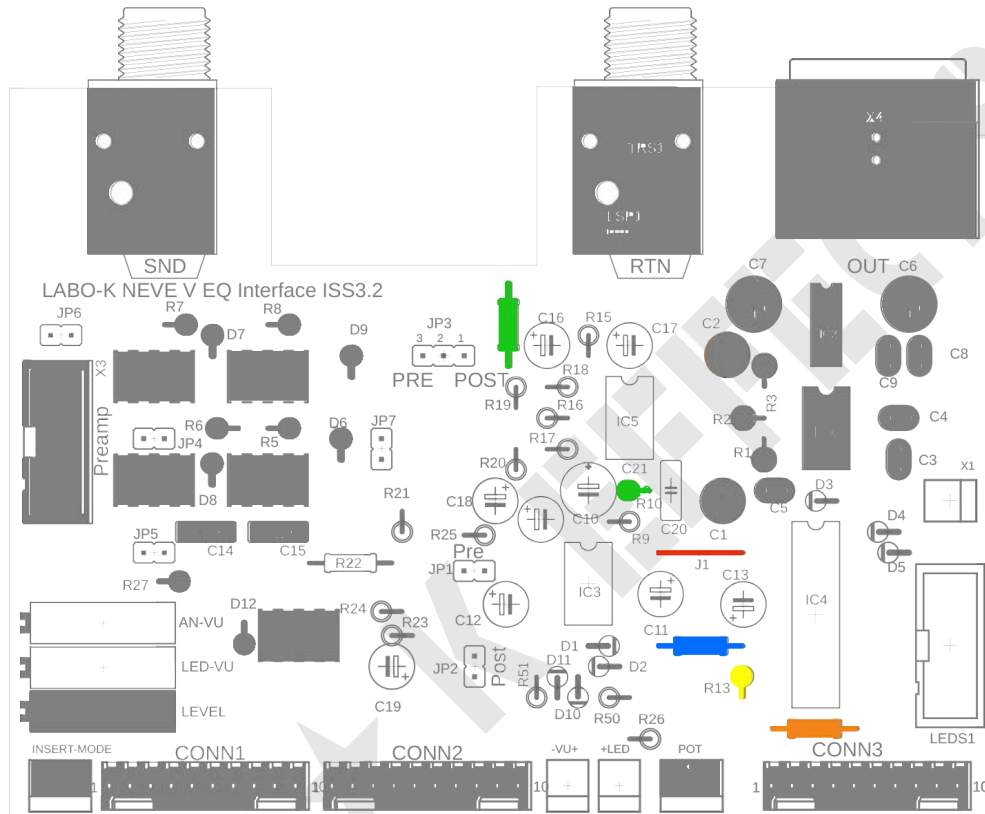

INSTALLATION INSTRUCTIONS LED METER PART 2

	47K	R9	1
	Trimmer 200K	LED VU	1
	1N4148	D1-D5	5
	DIL 8 socket	IC3	1
	DIL 18 socket	IC4	1

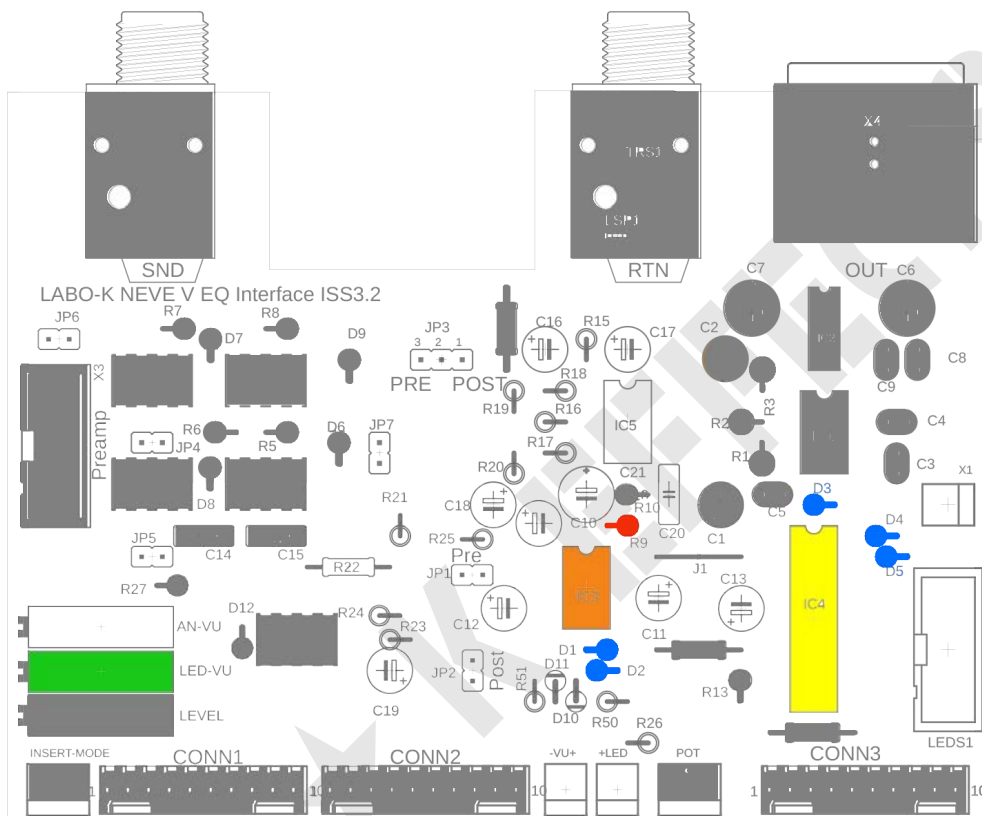

Pay attention to :
Diode layout

INSTALLATION INSTRUCTIONS LED METER PART 3

	IDC 10	LEDS1	1
	1u63V	C10, C13	2
	22u25V	C11, C12	2
	TL071	IC3	1
	LM3915	IC4	1

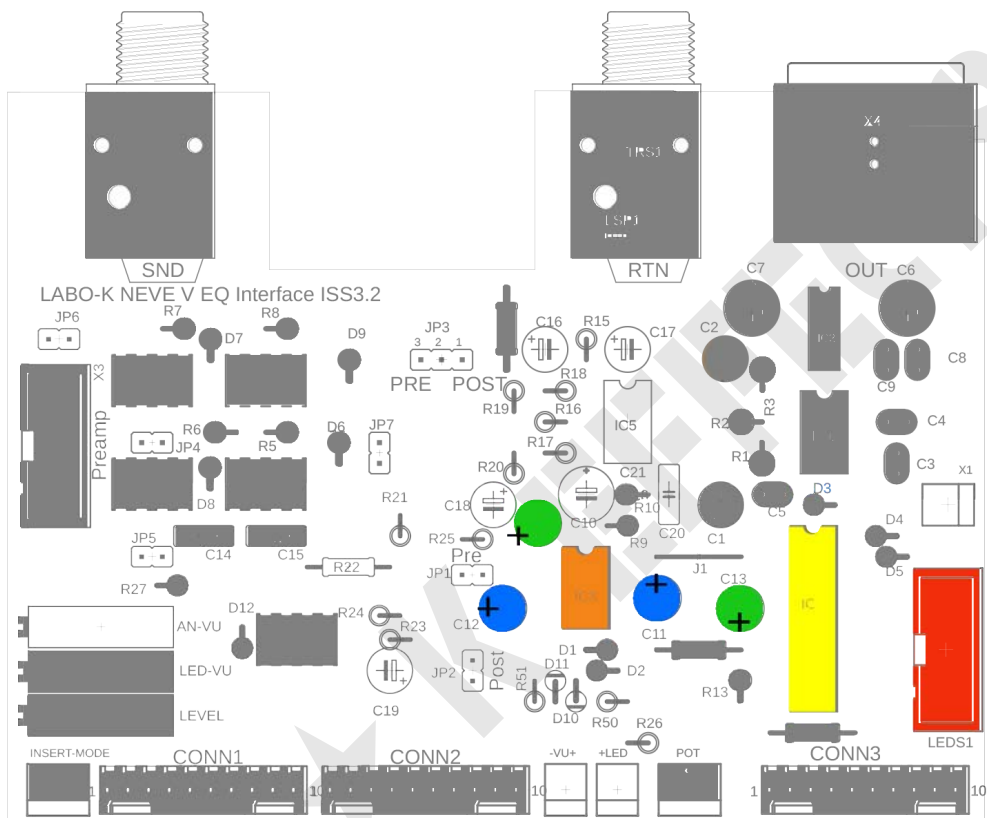

Pay attention to :
Diode layout

INSTALLATION INSTRUCTIONS LED METER PART 4 DLX

	Molex KK2	X1	1

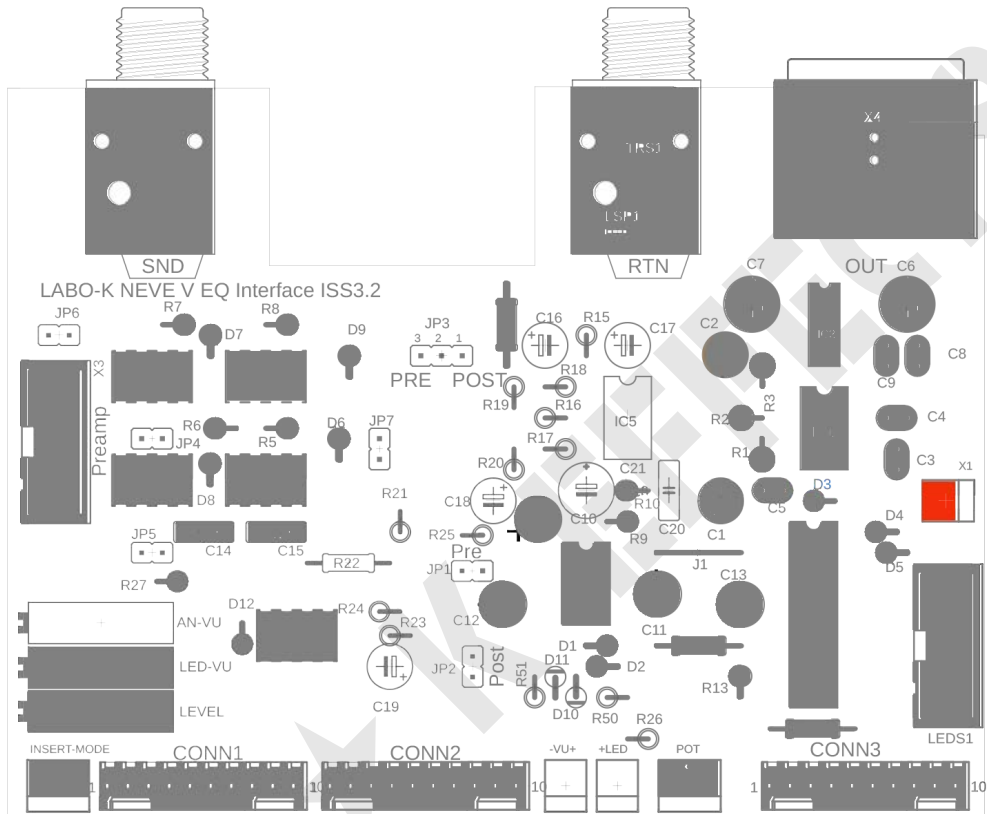

Pay attention to :
KK2 connector orientation

ANALOG VUMETRE ASSEMBLY INSTRUCTIONS PART 1

	100R	R22	1
	1K5	R26 vumeter Ird resistor	1
	3K3	R18, R19, R20, R21, R50, R51	6
	47K	R15, R16, R17, 23, R24, R25	6
	Trimmer 10K	AN VU	1

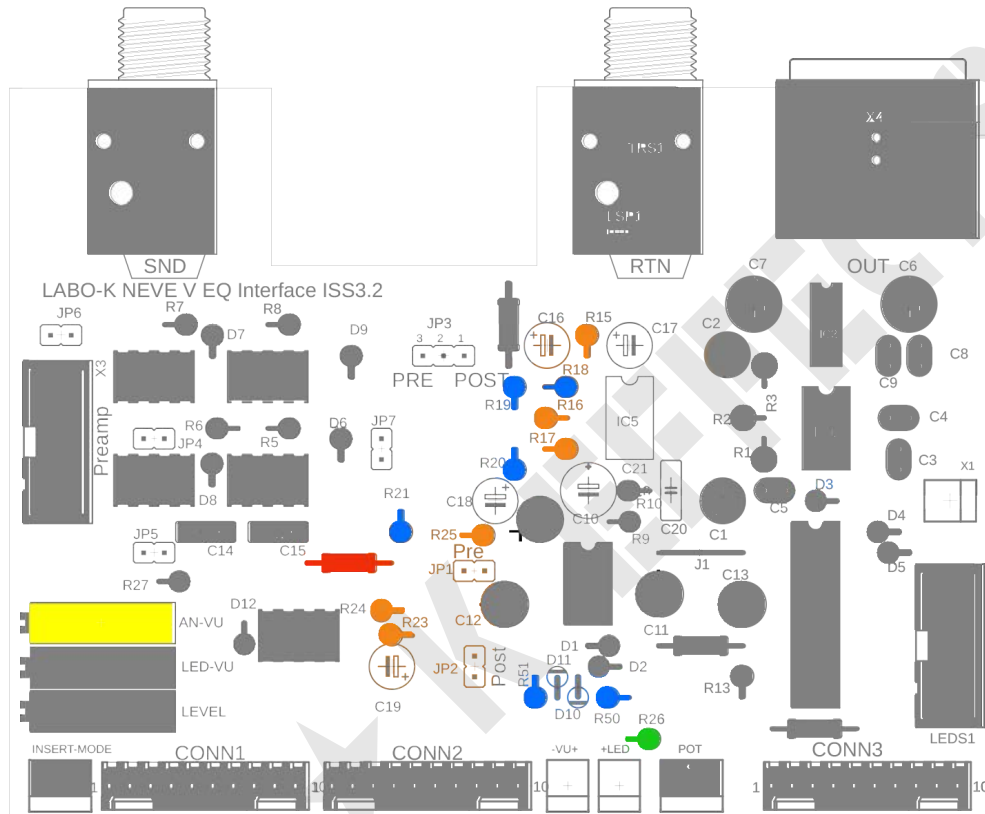

ANALOG VUMETRE ASSEMBLY INSTRUCTIONS PART 2

	BAT85	D1, D2	2
	22n Film	C20	1
	10u63V	C16, C17, C18, C19	4
	22u25V	C21	1
	DIL 8 Socket	IC1	1

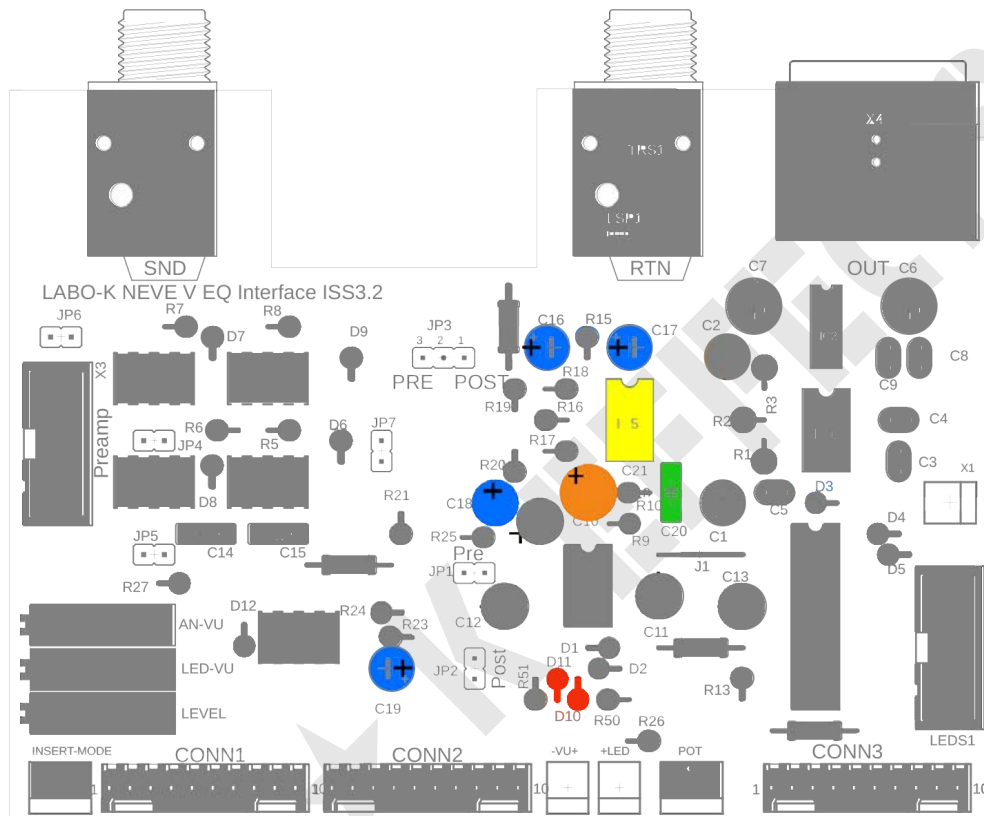

Pay attention to :

- Diode layout
- Positioning polarised capacitors

ANALOG VUMETRE ASSEMBLY INSTRUCTIONS PART 3

	TL071	IC1	1
	Molex KK2	VU, LED	2

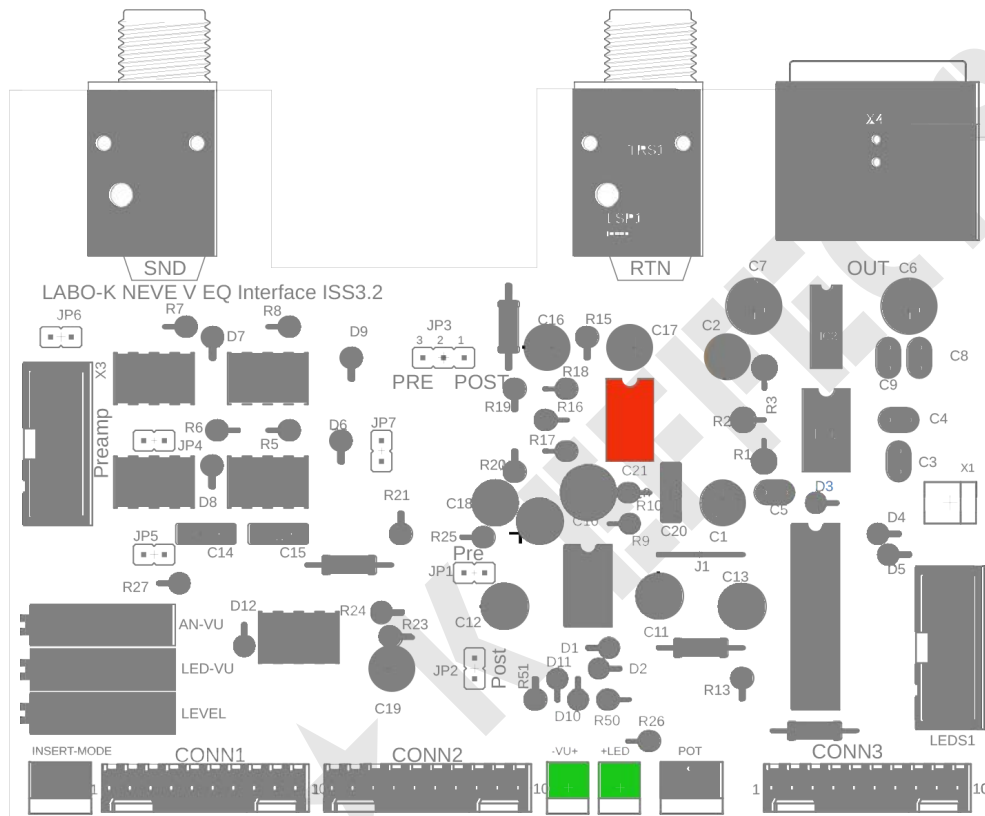

Pay attention to :
Orientation of KK2 connectors

ASSEMBLY INSTRUCTIONS SIGNALLING OPTIONS

	JP4, JP5, JP6, JP7	Implant if the Matrix Insertion option is not used	
	JP1	VU-LED Input	
	JP2	VU-LED Output	
	JP3	In-out selection of analog vumeter	

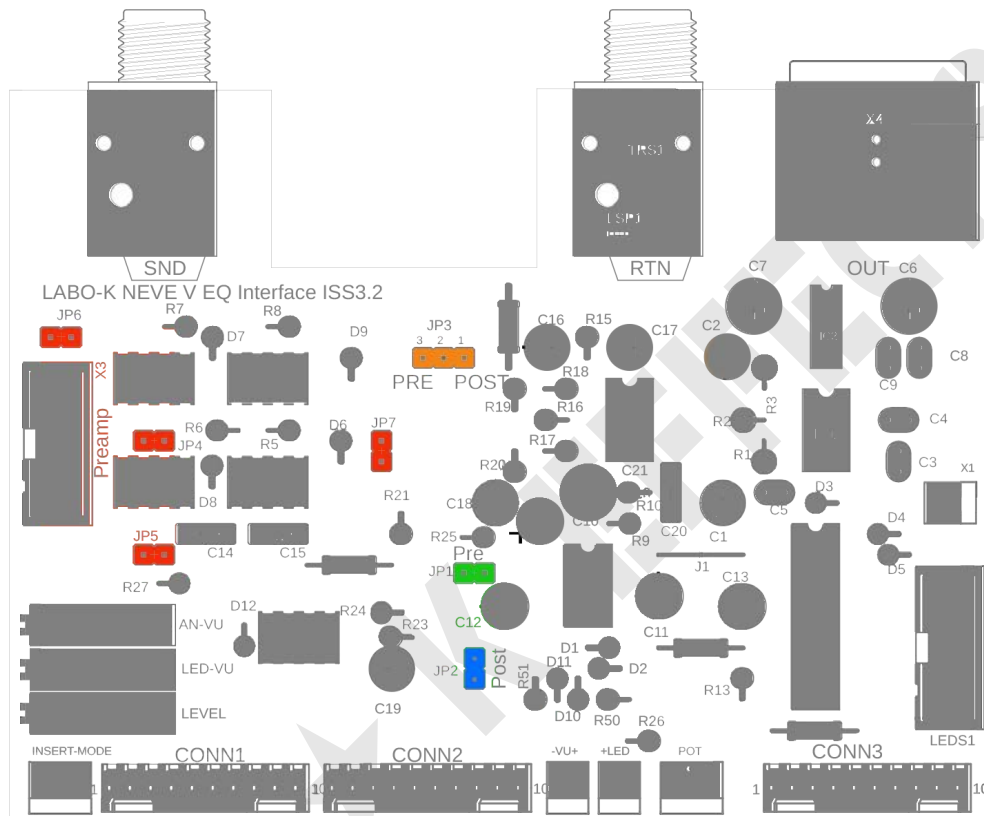

Placement of Jumpers vu led and vu analog :

The LED meter will display the input level if the jumper is set to JP1.

The LED meter will display the output level if the jumper is set to JP2.

The vumeter must be calibrated according to the option chosen

The analog meter will display the input level if JP3 is in the PRE position (3-2).

The analog meter will display the output level if JP3 is in position POST (1-2).

The vumeter must be calibrated according to the option chosen

It goes without saying that only one position per jumper is planned.

MAKING THE CONNECTION CABLES

The PSU ribbon connects the 51/V PSU power supply to the Input interface card. This ribbon also carries the dynamics chain loop when several preamps are connected. Once the components have been positioned in the rack, you need to measure the length required to connect the cards and the power supply, then cut a ribbon to the required length. Use a marker to mark the position of the connectors on the ribbon. Finally, crimp the female connectors to the previously marked positions. It is very important to observe the mark on pin 1 (triangle) and to place the red wire of the ribbon on this side.

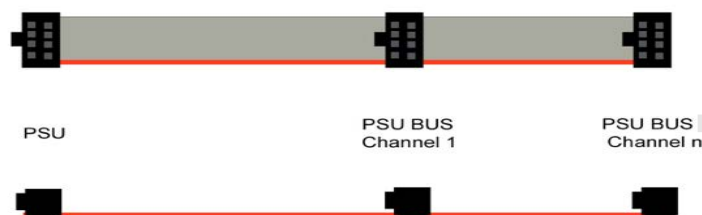

The **Intercard** ribbon links the Input Interface card to the EQ Interface card. It supplies it with signals and power supplies. (Figure 1)

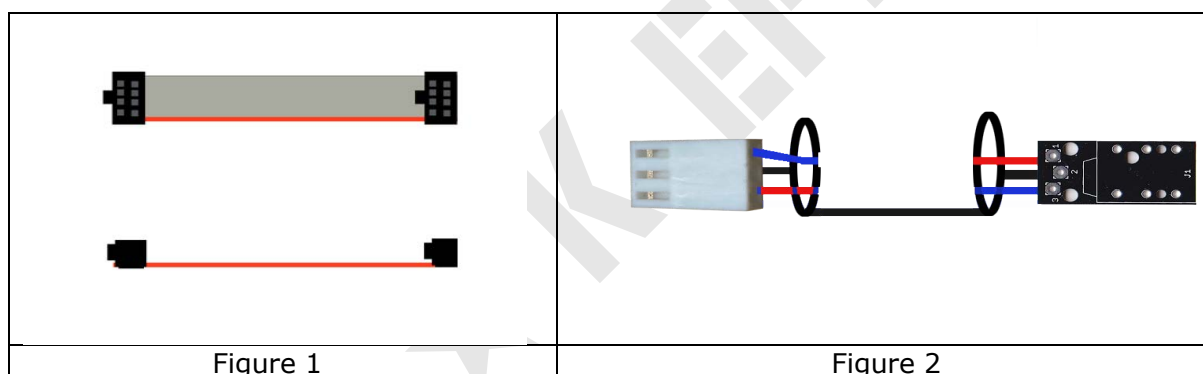

The **DI** cable links the jack connector to the instrument input on the Input Interface card. A shielded pair must be used. One wire of the cables carries the signal from the instrument, while the second one controls the DI activation relay depending on whether or not a jack is inserted in the connector on the front panel. (Figure 2)

Vu-Gain Reduction LED section ribbon

This ribbon is made from a 20-strand ribbon. Once the 20-pin IDC connector has been crimped, the ribbon is split into 2 x 10 strands. Then a 10-pin connector is crimped to each branch of the Y formed in this way.

CHAIN OF DYNAMICS

2 jumpers are used to define the position of the module in the chain

2 jumpers will be placed in JP1 and JP2 opposite the position number in the chain

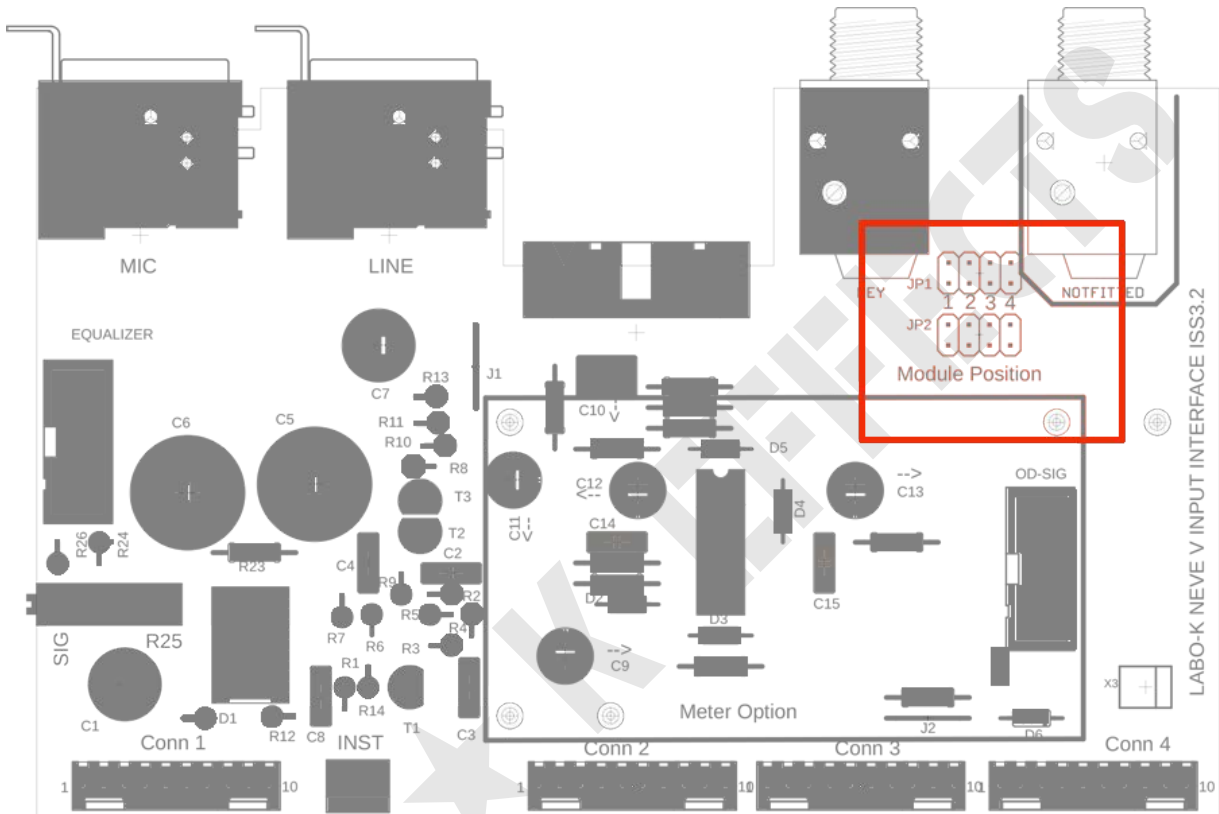

To link 4 Dynamics:

The 15 and 16 wires of the PSU BUS ribbon must be cut at the points shown.

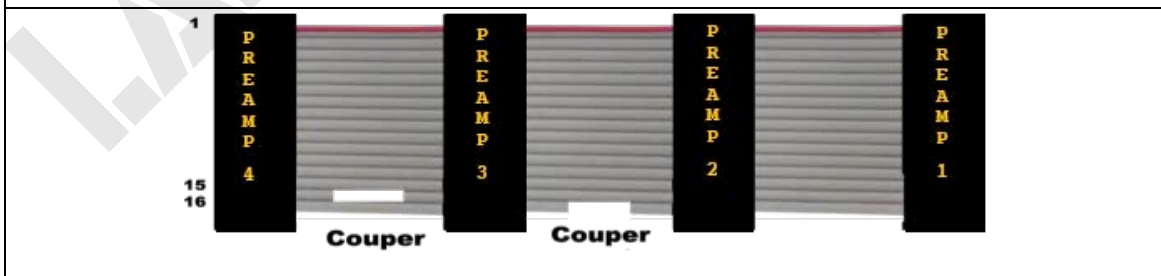

WIRING THE ELEMENTS PART 1

For greater clarity, the Input and EQ interfaces are laid out flat on the diagrams. It is of course possible to arrange these cards vertically, in which case the length of the ribbons will have to be adapted accordingly.

PSU BUS and Intercard ribbons

Instrument input wiring (INST)

Wiring of the Insertion Matrix command (INSERT MODE)

Wiring of the analog Vu meter and its LED (VU and LED)

Wiring of an output volume potentiometer (POT)

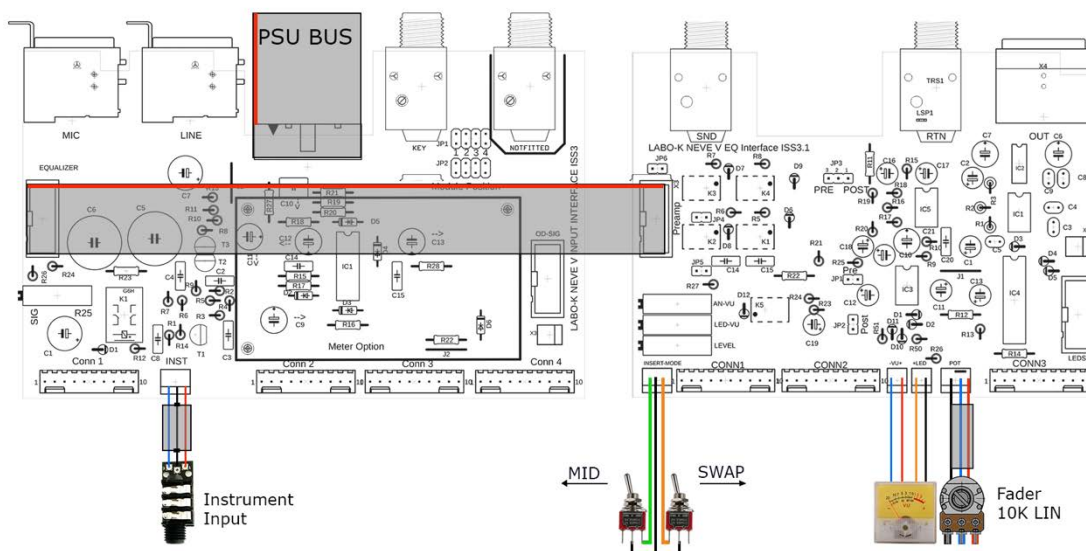

The ribbons will be made with AWG28 pitch 1.27 flat cable for the connectors supplied. Les différents câbles seront soudés et manchonnés sur les broches correspondantes des connecteurs KK males.

However, corresponding female connectors can be crimped.

Molex KK254 2-pin connectors

Molex KK254 3-pin connectors

Crimps: 08-50-0032

Two switches (not supplied) are used for Mid and Swap modes.

One 10K linear potentiometer (not supplied) is used for master volume.

WIRING THE ELEMENTS PART 2

Connection of the Vu, Overload and Gain Reduction V3 signalling board

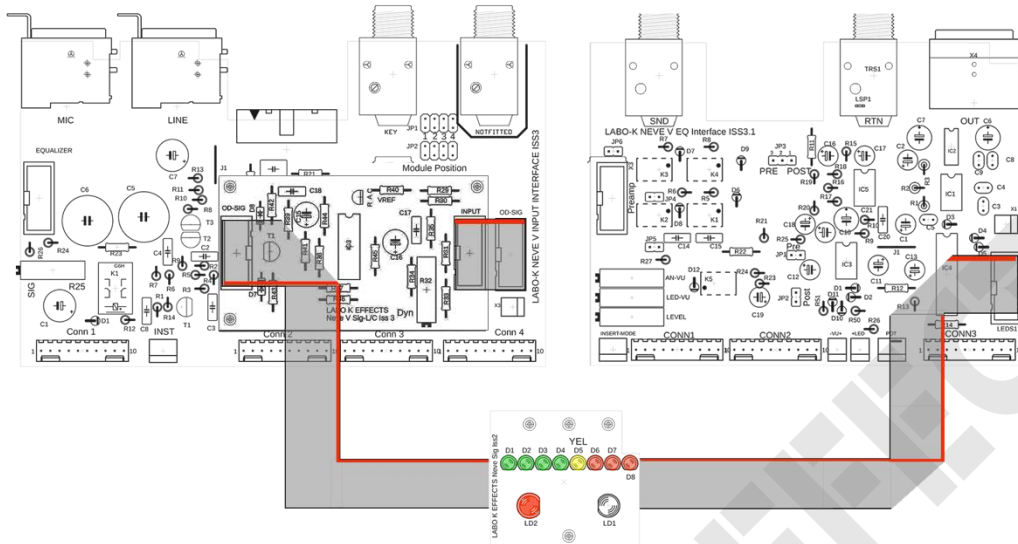

Connection of the Vu, Overload and Gain Reduction VR signalling board

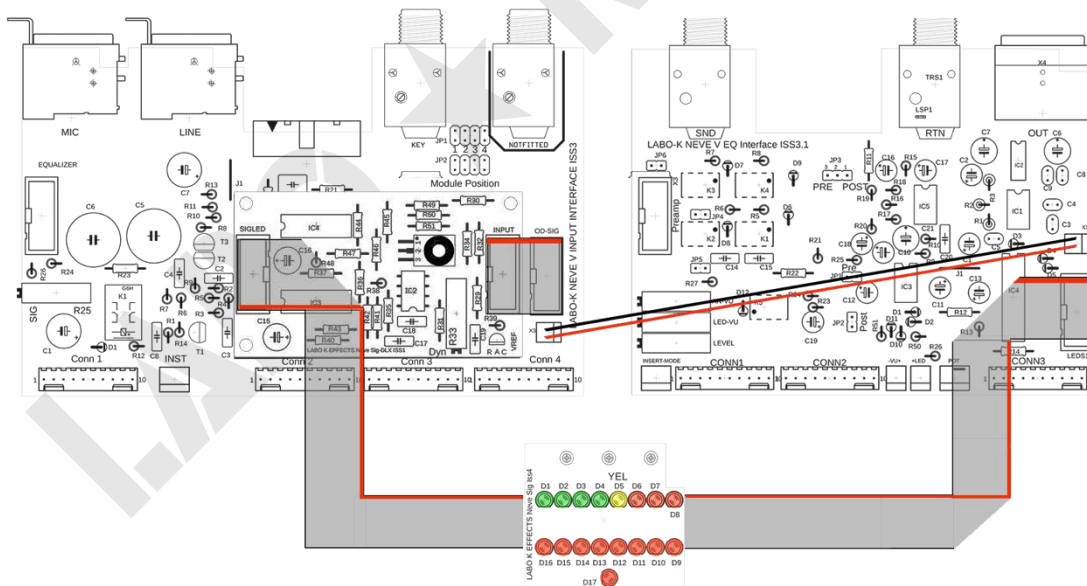

CHECKS

A good practice is to test the interface cards before connecting the modules.
Start by testing the power connections before powering up.
Use a beep to check that the supply voltage rails arrive at the correct points.
Start with the Input card alone.

The 0V should arrive at pin 10 of the CONN3 Molex connector.

The +16V rail must be connected to pin 5 of the CONN3 Molex connector

The -16V rail must be connected to pin 8 of the Molex CONN3 connector

The -15V rail must be connected to pin 7 of the Molex CONN4 connector

The +48V rail must be connected to pin 5 of the CONN3 Molex connector

Check that there are no shorts between these pins.

You can now connect the EQ interface board using the intercard ribbon.

Check that the above test pins are connected to the following Molex connectors on the EQ interface board.

Rail 0V Pin 10 of CONN3 (Input) to Pin 10 of CONN3 (EQ)

Rail +16V Pin 5 of CONN3 (Input) to Pin 5 of CONN3 (EQ)

Rail -16V Pin 8 of CONN3 (Input) to Pin 7 of CONN3 (EQ)

Rail -15V Pin 7 of CONN3 (Input) to Pin 6 of CONN3 (EQ)

Check that there are no shorts between these pins.

You can now power the boards and measure the voltages.

Switch off the power supply and connect the modules using their connector tabs.

The interface connectors are opposite the corresponding module ribbons.

Check that no mismatch has occurred when connecting the ribbon cables.

Switch on the power and check that the module LEDs can lit.

Enter audio in the input module. You should have audio output.

SETTINGS AND ADJUSTMENTS

To make the following settings, the following conditions must be met.
Audio input will be via the LINE input.
Set the gain trimmer to 0.
Check that the filters, equaliser and Dynamics are not engaged.
Apply a sinusoidal signal of frequency 1khz and amplitude 0dBm to the line input of the input module.

Output level adjustment

Connect a dB meter to the SND output of the EQ interface card.
The dB meter should read 0dBm. If not, it is likely that the link capacitors on the modules are not in optimum condition. (recapping required).
Connect a dB meter to the Out output of the EQ interface card.
Set the volume control potentiometer to the maximum position if fitted.
Adjust the LEVEL trimmer on the EQ card to read 0dBm at the output.
If you want more headroom, set the master volume knob to the number 7 out of 10 on the scale, for example, and assume that this is 0dB.
Adjust the LEVEL trimmer on the EQ card to read 0dBm at the output.
You should be able to read +4dB or so by turning the knob all the way up.

LED vumeter calibration

Reading the preamp input level (Jumper PRE) :
Adjust the LED-VU trimmer on the EQ board to light up the yellow LED on the vumeter.
Output level reading (Jumper POST):
Adjust the master volume to read 0dB on the dB meter connected to the output.
Adjust the LED-VU trimmer on the EQ card to light up the yellow LED on the vumeter.

Analog vumeter calibration

Reading the preamp input level (Jumper PRE) :
Adjust the AN-VU trimmer on the EQ board to set the needle of the vumeter to 0dB.
Reading the +4dB output level (Jumper POST):
Adjust the master volume to read +4dB on the dB meter connected to the output.
Adjust the AN-VU trimmer on the EQ card to set the meter pointer to 0dB.

Overload signal calibration



Adjust the SIG trimmer on the EQ card to start lighting up the signal LED.
Check that the LED goes out when you lower the input signal level slightly.
You can choose to display the presence of a signal below 0dB.
Inject this value at the input and adjust the trimmer in the same way.

Dyn trimmer adjustment













Adjust the Dyn trimmer on the SIG or DLX plugin boards so as to measure 0V +/- 10mV between the slider on this trimmer and 0V.

INPUT INTERFACE BOARD COMPONENTS LIST PART 1

















Basic version			
NAME	VALUE	VISUAL	REFERENCE
R1	100R		
J1	Strap		
C1	47u63V		
PSU BUS	IDC 16 connector		3M D2516-5002-AR
Equalizer	IDC 10 connector		3M N2510-6002-RB
Conn1	KK10 connector		Molex 22-23-2101
Conn2	KK10 connector		Molex 22-23-2101
Conn3	KK10 connector		Molex 22-23-2101
Conn4	KK10 connector		Molex 22-23-2101
MIC	XLR 3 F		Neutrik NC3FAHR2
LINE	XLR 3 F		Neutrik NC3FAHR2
KEY	TRS Jack		Neutrik NRJ6HF-1

Hi Z Instrument Input Option				
NAME	VALUE	VISUAL	REFERENCE	
R2	2M2			
R3	2M2			
R4	2M2			
R5	2M2			
R6	470R			
R7	2M2			
R8	100R			
R9	22R			
R10	2M2			
R11	100R			
R12	3K			
R13	2M2			
R14	10K			
C2	100n Film			
C3	100n Film			
C4	100n Film			
C5	100u BP			
C6	100u BP			
C7	100u63V			
C8	100n Film			
D1	1N4148			
T1	2N3904			
T2	K170 BL			
T3	K170 BL			
K1		Relais 12V	EA2-12NU	
INST	KK 3 connector		Molex 22-23-2031	

INPUT INTERFACE BOARD COMPONENTS LIST PART 2







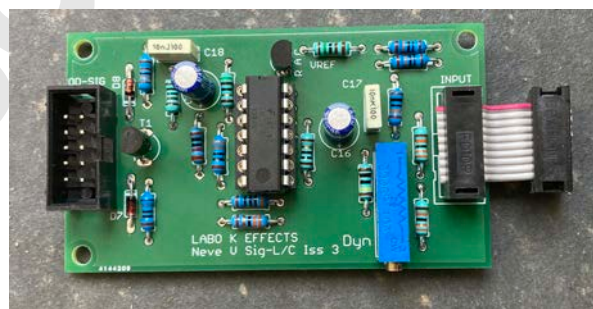















LED Vumeter option			
Section overload			
NAME	VALUE	VISUAL	REFERENCE
R15	10K		
R16	10K		
R17	10K		
R18	10K		
R19	10K		
R20	3K3		
R21	2M2		
R22	1K3		
R23	560K		
R24	68K		
R25	Trimmer 10K		3006P-1-103Z-LF
R26	68K		
R27	51R		
R28	51R		
C9	22u25V		
C10	680n		
C11	2u2		
C12	22u25V		
C13	22u25V		
C14	22n Film		
C15	22n Film		
D2	1N4148		
D3	1N4148		
D4	1N4148		
D5	1N4148		
D6	1N4148		
IC1	TL064	+ socket DIL 14	
OD-SIG	IDC 10 connector		3M N2510-6002-RB

LIST OF SIG/LC PLUGIN BOARD COMPONENTS

Gain reduction meter option			
NAME	VALUE	VISUAL	REFERENCE
R29	100K		
R30	100K		
R31	330K		
R32	Trimmer 10K		3006P-1-103Z-LF
R33	330K		
R34	1M		
R35	100K		
R36	33R		
R37	300R		
R38	330R		
R39	1K		
R40	1K5		
R41	10K		
R42	1K3		
R43	680R		
R44	51R		
R45	51R		
C15	22u25V		
C16	22u25V		
C17	10n Film		
C18	10n Film		
D7	1N4148		
D8	1N4148		
VREF	TL431		
INPUT	IDC 10 connector		3M N2510-6002-RB
OD-SIG	IDC 10 connector		3M N2510-6002-RB
IC3	LM339	+ DIL14 socket	



LIST OF DLX PLUGIN BOARD COMPONENTS

DLX Meter section option			
NAME	VALUE	VISUAL	REFERENCE
R29	100K		
R30	100K		
R31	100K		
R32	100K		
R33	Trimmer 10K		3006P-1-103Z-LF
R34	100K		
R35	100K		
R36	10R		
R37	10R		
R38	15K		
R39	1K5		
R40	220R		
R41	200R		
R42	150R		
R43	150R		
R44	100R		
R45	200R		
R46	100R		
R47	51R		
R48	51R		
R49	200R		
R50	2K7		
R51	30K		
C15	22u25V		
C16	22u25V		
C17	10n Film		
C18	10n Film		
C19	10n Film		
T1	MJE171		
INPUT	IDC 10 connector		3M N2510-6002-RB
OD-SIG	IDC 10 connector		3M N2510-6002-RB
IC2	TL071	+ DIL8 socket	
IC3	LM339	+ DIL14 socket	
IC4	LM339	+ DIL14 socket	
VREF	TL431		

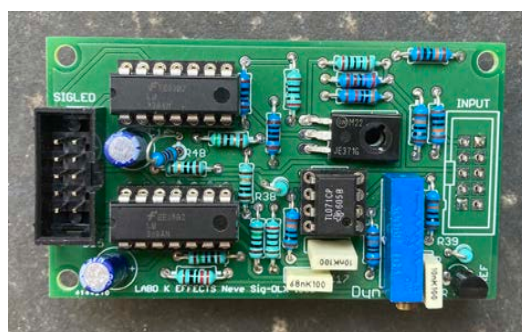

LIST OF SIG/LC LED BOARD COMPONENTS

Gain reduction meter option			
NAME	VALUE	VISUAL	REFERENCE
D1	LED 3mm	Green	
D2	LED 3mm	Green	
D3	LED 3mm	Green	
D4	LED 3mm	Green	
D5	LED 3mm	Yellow	
D6	LED 3mm	Red	
D7	LED 3mm	Red	
D8	LED 3mm	Red	
LD1	LED 5mm	Bicolour	
LD2	LED 5mm	Red	
Conn1	IDC 20		AWLP-20

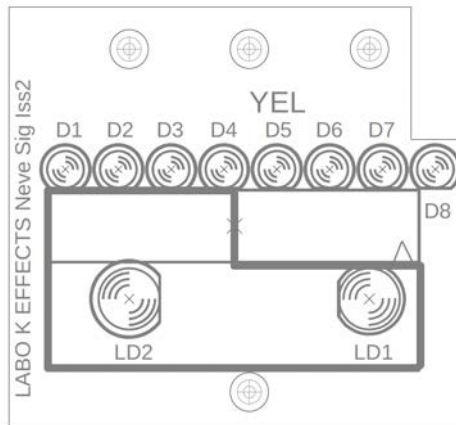

LIST OF DLX LED BOARD COMPONENTS



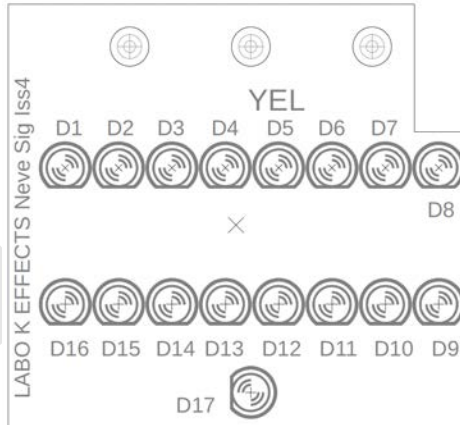

DLX Meter section option			
NAME	VALUE	VISUAL	REFERENCE
D1	LED 3mm	Green	Vu metre
D2	LED 3mm	Green	Vu metre
D3	LED 3mm	Green	Vu metre
D4	LED 3mm	Green	Vu metre
D5	LED 3mm	Jaune	Vu metre
D6	LED 3mm	Red	Vu metre
D7	LED 3mm	Red	Vu metre
D8	LED 3mm	Red	Vu metre
D9	LED 3mm	Red	Gain Reduction
D10	LED 3mm	Red	Gain Reduction
D11	LED 3mm	Red	Gain Reduction
D12	LED 3mm	Red	Gain Reduction
D13	LED 3mm	Red	Gain Reduction
D14	LED 3mm	Red	Gain Reduction
D15	LED 3mm	Red	Gain Reduction
D16	LED 3mm	Red	Gain Reduction
D17	LED 3mm	Red	Signal-Overload
Conn1	IDC 20		AWLP-20



EQ INTERFACE BOARD COMPONENTS

Basic option			
NAME	VALUE	VISUAL	REFERENCE
R1	18K		
R2	1K2		
R3	3K6		
C1	100u10V		
C2	100u10V		
C3	22p Ceramic		
C4	100n Ceramic		
C5	100n Ceramic		
C6	22u25V		
C7	22u25V		
C8	100n Ceramic		
C9	100n Ceramic		
IC1	NE5534	+ DIL8 socket	
IC2	THAT1646	+ DIL8 socket	
LEVEL	Trimmer 10K		3006P-1-103Z-LF
X3	IDC 10 connector	Preamplifier	3M N2510-6002RB
Conn1	KK 10 connector		Molex 22-23-2101
Conn2	KK 10 connector		Molex 22-23-2101
Conn3	KK 10 connector		Molex 22-23-2101
SND	TRS Jack	Insertion Send	Neutrik NRJ6HF-1
RTN	TRS Jack	Insertion Return	Neutrik NRJ6HF-1
OUT	XLR 3 F	Output	Neutrik NC3MAHR















INSERT MATRIX COMPONENTS

Matrix			
NAME	VALUE	VISUAL	REFERENCE
R5	3K		
R6	3K		
R7	3K		
R8	3K		
R27	3K		
C14	100n Film		
C15	100n Film		
D6	1N4148		
D7	1N4148		
D8	1N4148		
D9	1N4148		
D12	1N4148		
K1	12V relay		G6K-2P 12V
K2	12V relay		G6K-2P 12V
K3	12V relay		G6K-2P 12V
K4	12V relay		G6K-2P 12V
K5	12V relay		G6K-2P 12V
INS Mod	KK 3 connector	Matrix	Molex 22-23-2031

LED VUMETRE DRIVER COMPONENTS

Option Vu mètre à LEDS			
NAME	VALUE	VISUAL	REFERENCE
J1	Jumper		
R9	47K		
R10	100R		
R11	100R		
R12	180R		
R13	3K3		
R14	1K		
C10	1u63V		
C11	22u25V		
C12	22u25V		
C13	1u63V		
LED-VU	Trimmer 200K		
D1	1N4148		
D2	1N4148		
D3	1N4148		
D4	1N4148		
D5	1N4148		
IC3	TL071	+ DIL8 socket	
IC4	LM3915	+ DIL18 socket	
LEDS1	IDC 10 connector		3M N2510-6002RB

ANALOG VUMETRE DRIVER COMPONENTS

Analogue Vumeter Option			
NAME	VALUE	VISUAL	REFERENCE
R15	47K		
R16	47K		
R17	47K		
R18	3K3		
R19	3K3		
R20	3K3		
R21	3K3		
R22	100R		
R23	47K		
R24	47K		
R25	47K		
R26	1K5		
R50	3K3		
R51	3K3		
C16	10u63V		
C17	10u63V		
C18	10u63V		
C19	10u63V		
C20	22n Film		
C21	22u25V		
ANA-VU	Trimmer 10K	ANALOG VU	3006P-1-103Z-LF
D1	BAT85		
D2	BAT85		
IC1	TL071		
VU	Connecteur KK 2	Vumeter	Molex 22-27-2021
LED	Connecteur KK 2	Vumeter LED	Molex 22-27-2021

PINOUTS

Input Interface

PSU BUS	
1	+48V
2	+48V
3	GND
4	GND
5	GND
6	GND
7	+16V
8	+16V
9	+16V
10	+16V
11	-15V
12	-15V
13	-16V
14	-16V
15	Loop Out
16	Loop In

INST	
1	Input
2	GND
3	Remote

EQ Interface

INSERT MODE	
1	Mid control
2	GND
3	Swap control

VU	
1	+
2	-

LED	
1	+Anode
2	-Cathode

POT	
1	GND
2	Wiper
3	Input

DRILLING TEMPLATE

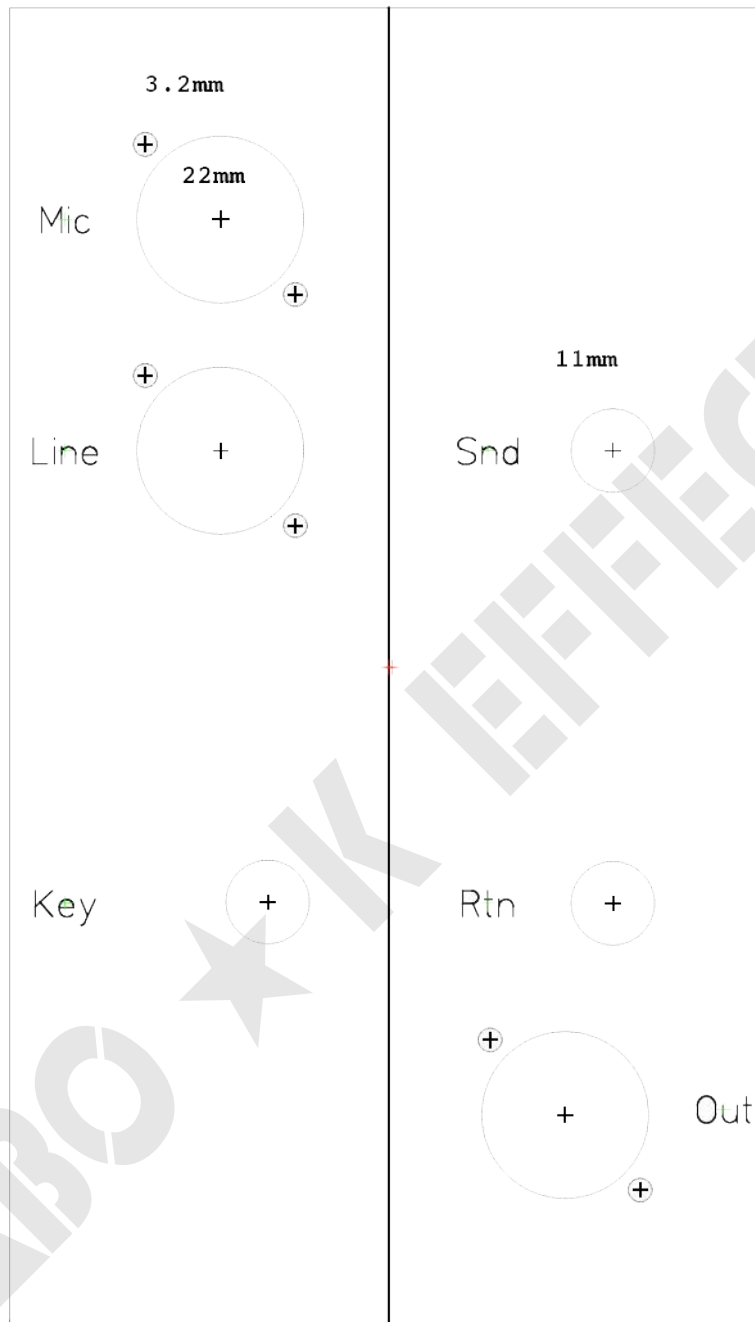

Legal notice:

Labo ★ K Effects shall not be responsible and disclaims all liability for any damage (whether direct or consequential) that may result from a wrong use of the kit by the user.